

BIO TEEM IMPLANT SYSTEM

AR | Submerged Implant System

IR | Tissue Level Implant System

BR | External Hex Implant System

MR | One Body Implant System

BIOTEM Surgical Kit

SANTA & BIOARK

BIO^{TEEM}EM
DENTAL IMPLANT SYSTEM

CEO's Message	04
History	06
Doctor's Recommendation Letter	08
Biotem Implant Surface Feature	10
AR Submerged Implant System	
AR Implant Features	14
AR Drilling Sequence	15
AR Fixture	17
AR Abutment	19
AR Prosthetic Flow Chart	20
AR Abutment	21
AR Prosthetic Flow Chart	22
AR Impression Coping	30
AR Lab Analog	33
AR Prosthetic Flow Chart	34
AR Multi Abutment	35
AR Multi Component	36
AR Prosthetic Flow Chart	38
AR Locator Abutment	39
AR Abutment Locator Component	40
AR Ball Abutment & Component	41
SANTA & BIOARK	45
IR Tissue Level Implant System	
IR Implant Features	48
IR Prosthetic Flow Chart	49
IR Drilling Sequence	50
IR Screw & Abutment	53
IR Analog & Coping	56
BR External Hex Implant System	
BR Implant Features	60
BR Prosthetic Flow Chart	61
BR Drilling Sequence	62
BR Abutment	65
BR Abutment & Coping	68
BR Lab Analog & Coping	69
MR One Body Implant System	
MR Drilling sequence	72
MR Fixture	73
MR Implant Narrow Ridge Components	75
MR Implant Denture Components	77
BIOTEM Surgical Kit	
Surgical Kit	80
Surgical Kit Component	80
Other Component	85
Convenient Kit	86
Convenient Kit Component	87
MR Kit	89
MR Kit Component	90
Surgical Guide Kit	92
Surgical Guide Kit Component	92
How to join with a Fixture Driver	96
Certificates	97



*Hot heads and cold hearts never solve anything
Cold heads and hot hearts can solve everything!*

Our Company, Biotem Co. Ltd, has been working to improve and enhance dental implant technology for many years in order to provide the most satisfying product for both patients and dentists.

With this accumulated experience, our technical know-how has reached a very high level. We have gained international certificates such as ISO 13485, CE together with KGMP, and we have stepped into the world-wide market.

Currently, Korea's standard of dental implant technology is one of the best, most advanced in the world. Patients are now seeking a more advanced implant service. Therefore, to meet the patient's high expectations, dentists and implant companies have been trying to increase their technological standards.

For this reason, Biotem has also developed a new technology, called Bio-Dental Implant System, and soon we can start the mass production process. Biotem implant products - "Dentists can operate more safely and easily and patients can be satisfied with full credibility." We will make every effort to become an excellent world-leading implant company that will keep developing innovative technology in order to improve the lives of people around world.

Sincerely Yours.

Biotem Corp. CEO Young-ho, Lee



주식회사 바이오템은 수년간 임플란트를 연구하고 개발해 온 회사로서, 임플란트 시술자와 환자에게 최고의 만족감을 드리기 위해 끊임없이 노력하는 치과용 임플란트 생산 전문기업입니다.

바이오템은 오랜 노하우로 축적된 뛰어난 기술력을 바탕으로 KGMP는 물론 CE, ISO13485 등 세계적인 품질 인증기관으로부터 인증서를 획득하여 우리나라 뿐 아니라, 세계 시장으로 빠르게 뻗어 나가고 있습니다.

현재 대한민국의 임플란트 수준은 세계 치과의료계에서도 당당히 선진국 수준으로 자리매김 하였습니다. 이로 인해 환자들은 더욱 선진화된 임플란트 시술을 요구하고 있으며, 이는 시술자에게 큰 과제 일 뿐 아니라, 치과용 임플란트를 제조하는 회사에게도 아주 큰 과제 입니다.

세계적인 수준의 의료기술과 환자의 높은 의식 수준에 부응하고자, 우리 바이오템은 수년간의 임상 경험을 바탕으로 친환경 임플란트 기술을 국내 최초로 개발하였고, 현재 이 기술은 상용화 단계에 이르렀습니다. 이러한 기술력을 바탕으로 제품의 안전성과 시술의 편의성을 극대화하여, 시술자는 더욱 안전하고 손쉽게, 환자들에게는 시술의 신뢰와 만족을 줄 수 있는 임플란트가 되도록 항상 연구하며, 새로운 기술을 개발하고 있습니다.

항상 도전하는 정신과 끊임없는 투자를 통해 임플란트의 선진기술과 꿈을, 전 세계로 키워 나가는 초일류 임플란트 전문기업으로 성장하겠습니다.

감사합니다.

바이오템(주) 대표이사 **이 영 호**

HISTORY

2021	06 01	Korea DINDEX exhibition participation Russia Certificate
2020	02 02 01	Participated in WCUPS in Philippines (Contract with agency of Philippines) AEEDC(DUBAI Exhibition) (Contract with agency of Iraq, Egypt) Japan Certificate
2019	09 06 03	Live Surgery in Hochiminh, Vietnam Participated in WCUPS in Netherland Germany Cologne IDS Exhibition Participation (Contract with agency of Russia)
2018	03	Phuket Thailand BIOTEM World Symposium
2017	10 06 03 01	F.D.A Certificate Korea DINDEX exhibition participation Germany Cologne IDS exhibition participation. (Contract with agency of Portugal, Italy, Jordan, Swiss etc.) Participated in WCUPS in India
2016	10 10 06	Establishment of BIOTEM Implant Ltd. in Thailand. Singapore IOCI participation Korea DINDEX exhibition participation
2015	05 03	Korea SINDEX exhibition participation Germany Cologne IDS exhibition participation (Contract with agency of England, Thailand and Myanmar)
2014	11 09 06	Purchase new factory in Busan. Establishment company-affiliated R&D center. Selected to be an export promising company.
2013	03 02 01	Germany Cologne IDS exhibition participation (Contract with agency of Chile and Iran) Dubai exhibition participation. Contract with agency of Spain.
2012	09 06	Purchase a place for business in Seongnam city. Korea SINDEX exhibition participation. (Contract with agency of China.)
2011	03	Germany Cologne IDS exhibition participation (Contract with agency of Lebanon, Turkey and Peru)
2010	11	Selected to be a venture capital company.
2009	10 06 03 01	Obtained CE certification. Obtained ISO13485:2003 certification. Obtained certification of "AR"(Internal Sub - Merged type Fixture) (Cert. No. 09-156) Obtained certification of "IR"(Internal One - Stage type Fixture) (Cert. No. 09-56)
2008	12 11 08	Obtained KGMP certification. Obtained certification of "Abutment" (Cert. No. 08-833) Obtained certification of "BR"(External Hex type Fixture). (Cert. No. 08-834) Obtained license of "Manufacturing of medical devices" (KFDA) Establishment of BIOTEM Implant factory in Busan, Korea.
2006	03	Launching of "New Development of Biotem implant system"

HISTORY

2021	06 01	한국 DINDEX 참가 러시아 인증
2020	02 02 01	필리핀 보라카이 세계초음파학회 참가 (필리핀 에이전시 계약체결) 두바이 전시회 참가 (이라크, 이집트 등 계약체결) 일본 인증
2019	09 06 03	베트남 호치민 Live Surgery 행사 네덜란드 WCUPS 참가 독일 IDS 참가 (러시아 등 에이전시 계약체결)
2018	03	태국 푸켓 바이오템 월드심포지움 개최
2017	10 06 03 01	F.D.A 인증 한국 DINDEX 참가 독일 ids 참가 (포르투갈, 이탈리아, 요르단, 스위스 등 에이전시 계약 체결) 인도 WCUPS 참가
2016	10 10 06	태국에 법인 설립 (BIOTEM Implant. Ltd) 싱가포르 IOCI 참가 한국 DINDEX 참가
2015	05 03	한국 SINDEX 참가 독일 IDS 참가 (영국, 태국, 미얀마 에이전시 계약 체결)
2014	11 09 06	신규 공장 매입(부산 모라동) 기업 부설 연구소 설립 수출 유망 중소기업 선정
2013	03 02 01	독일 IDS 참가 (칠레, 이란 에이전시 계약 체결) 두바이 전시회 참가 스페인 에이전시 계약 체결
2012	09 06	성남 우림 라이온스밸리 매입 한국 SINDEX 참가 (중국 에이전시 계약 체결)
2011	03	독일 쾰른 IDS 참가 (레바논, 터키, 페루와 에이전시 계약 체결)
2010	11	벤처기업선정
2009	10 06 03 01	CE인증 ISO13485 인증(PCA) "AR"(Internal Sub - Merged type Fixture) 품목허가 인증 (제허09-156호) "IR"(Internal One - Stage type Fixture) 품목허가 인증 (제허09-56호)
2008	12 11 08	KGMP 획득 (KFDA & KTL) Abutment 품목허가 인증 (제허08-833호) "BR"(External Hex type Fixture) 품목허가 인증 (제허08-834호) 제조업 허가 인증(KFDA) 주식회사 바이오템 법인설립
2006	03	Biotem implant system 개발 추진

Recommended!



**Prof. Sohn | Daegu Catholic University
Dental clinic from Korea**

I have experienced over than 20 years of implant and Biotem implant is one of the best solution to the patients as it is very easy to surgery, good result of symptoms and most fittable to the prosthetic process.



Dr. Eric Park | U.S.A

After placing substantial number of implants with extensive surgical procedures, I had realized the importance of 3 factors for the successful implant treatment , good initial stability, surface treatment for reliable osseointegration, and accurate engagement between parts for minimal crestal bone loss. Biotem implant proved to be superior at all 3 aspects both in vivo and in vitro test.

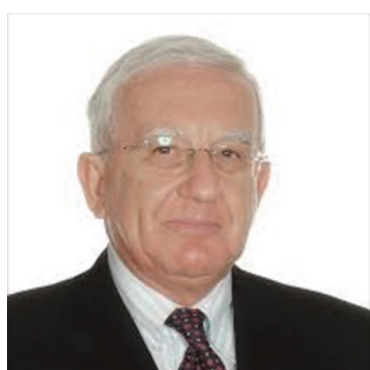

Dr. Adriano | Italy

I have placed over than 20 years of Implant and I have encountered with a new and innovational implant system which have a perfect outcome in the clinical evaluation. And it is Biotem implant and it is the future dental implant system.

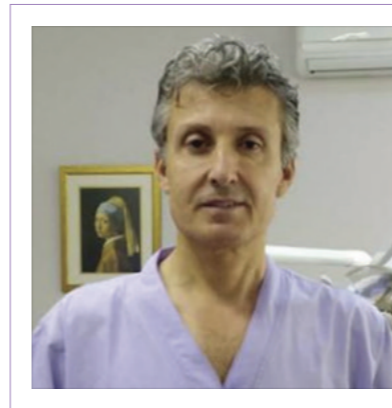

Dr. Raymond | Lebanon

After working with implants for over 15 years, I discovered that Biotem implants' quality and user-friendliness match the best international products, they provide high satisfaction and top performance.

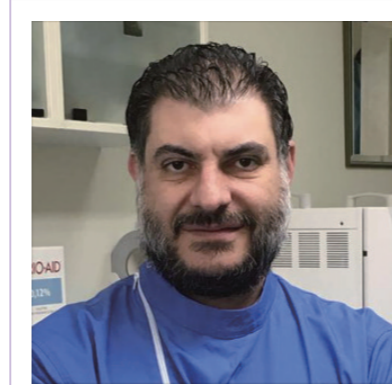

Dr. Roger Saleh | Lebanon

The structure of the Biotem Implants make the implant procedure simple and time efficient. I've been using their implants for over 3 years with excellent results, over a 99% success rate and an aesthetic outcome that the patients appreciate.

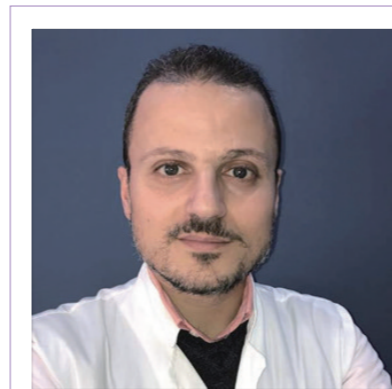

Dr. Maleck | Lebanon

Having worked for 5 years with top notch implants from around the globe, Biotem implant procure un matched user friendly features, very low failure rate along with professional follow up and great service from the manufacturer and dealer.

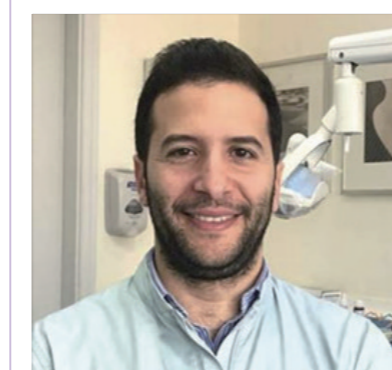

Dr. Ali Kodr | Lebanon

I am working in the same clinic with my father who has a very big experience in implantology. He advised me first to place Biotem implant as a trial since he just had the feeling of being a good implant system. After many implants placed. I realized that we can achieve the best result possible with Biotem and we are fulfilling all our patients needs from both sides, function and aesthetics. I recommend every clinic to use Biotem implant for the sake of their patients.

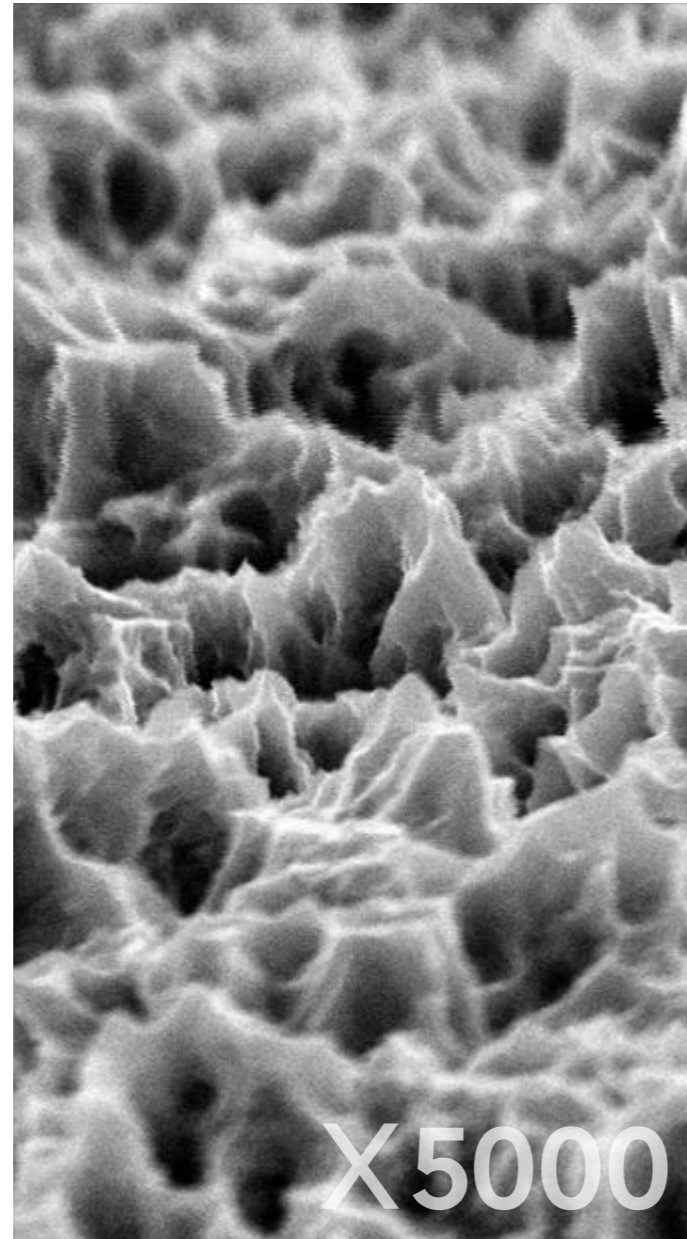
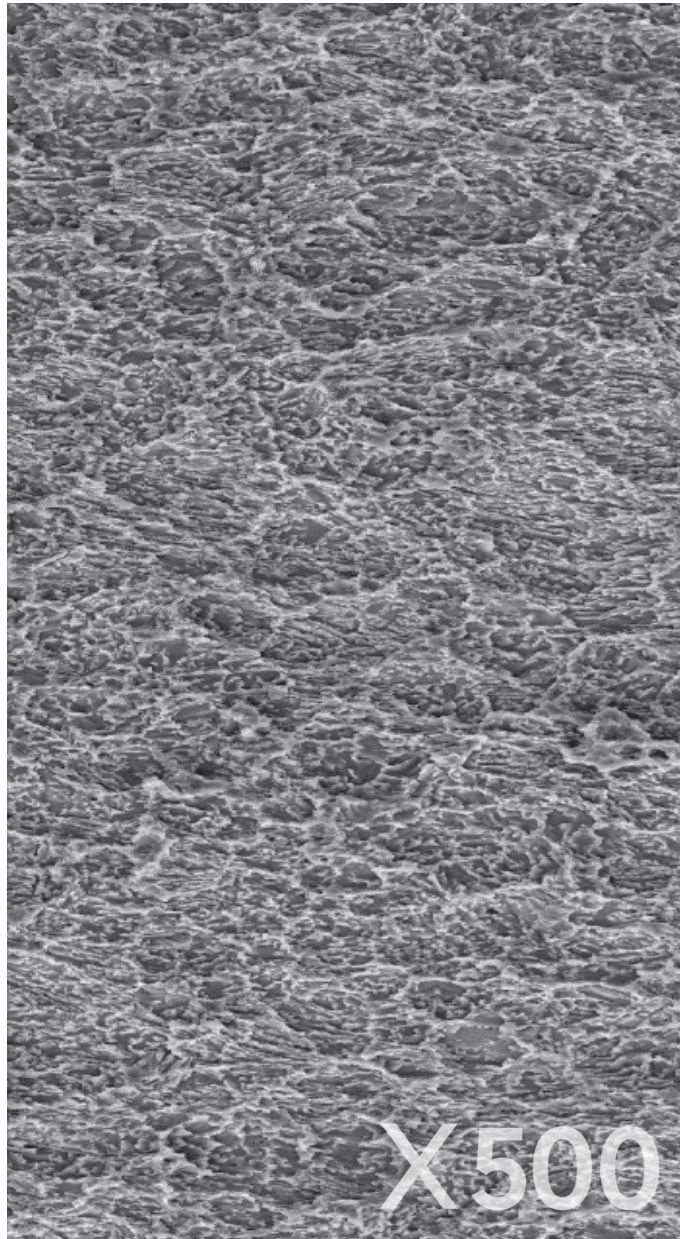
S.L.A (RA 2.2 μ m)

BIOTEM
DENTAL IMPLANT SYSTEM

SANDBLASTED, LARGE-GRIT, ACID-ETCHED

The SLA surface is produced by a large grit sand-blasting. The surface is not microporous and therefore provides no enclosed volumes to reduce vulnerability to bacteria. This method analyses the first few atomic layers of the surface, and thus the chemical composition of the material which is in direct contact and interacts with tissue fluids and cells.

AR | SUBMERGED IMPLANT SYSTEM

BIO?EM
DENTAL IMPLANT SYSTEM

AR Submerged Implant System	14
FXAR 3.4 Drilling Sequence	15
ASTFA 3.5 / FXAR 3.7 Drilling Sequence	15
ASTFA 4.0 / FXAR 4.0 Drilling Sequence	15
ASTFA 4.5 / FXAR 4.5 Drilling Sequence	16
ASTFA 5.0 / FXAR 5.0 Drilling Sequence	16
ASTFA 6.0 / FXAR 6.0 Drilling Sequence	16
Non-Micro Thread AR Fixture SLA	17
Tapered AR Fixture SLA	18
Cover Screw	19
Healing Abutment	19
Solid Abutment	21
Cemented Abutment (Hex)	23
Cemented Abutment (Non-Hex)	24
Milling Abutment (Hex)	25
Temporary Abutment (Hex)	26
Temporary Abutment (Non-Hex)	26
Angled Abutment (Hex) A-Type	27
Angled Abutment (Hex) B-Type	28
Angled Abutment (Non-Hex)	29
Ti-base Abutment	29
Transfer Impression Coping (Hex)	30
Transfer Impression Coping (Non-Hex)	30
Pick-up Impression Coping (Hex)	31
Pick-up Impression Coping (Non-Hex)	31
Plastic Impression Coping	32
Burn-Out Cylinder	32
Fixture Lab Analog	33
Solid Lab Analog	33
Multi Angled Abutment (All-on-4)	35
Multi Abutment	35
Multi Temporary Cylinder	36
Multi Transfer Impression Coping	36
Multi Lab Analog	36
Multi Healing Cap	37
Multi Plastic Cylinder	37
Multi Abutment Outer Driver	37
Locator Abutment (Narrow)	39
Locator Abutment (Regular)	39
Denture Cap	40
Ball Abutment	41
Retainer Cap Set	41
O-ring	41
O-ring Lab Analog	42
O-ring Abutment Torque driver	42

AR | Submerged Implant System

Single Pitch Macro Thread

- 0.7pitch x 0.15depth x double thread
- Synchronized thread
- Optimized design for (SLA/RBM) surface
- Reinforce fixture strength

Morse Tapered Connection 11°

- The Fixture & Abutment interface ensures hermetic sealing
- This distributes the load to the fixture evenly. Therefore, it minimized bone loss

Corkscrew Thread

- 0.7pitch x 0.35depth x double thread
- Powerful self threading
- Keep implant path
- Easy to change the path
- High initial stability
- Decrease sensitivity on drill size

Taper degree 1.5°

- Easy to get initial stability in soft bone

Helix Cutting Edge

- Powerful self threading
- Easy path change

Apical

- Self drilling ability
- Increased initial stability at fresh extraction socket

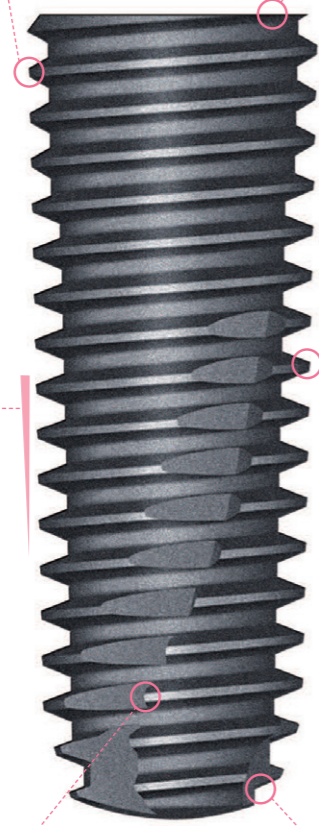

FXAR 3.4 | Drilling Sequence

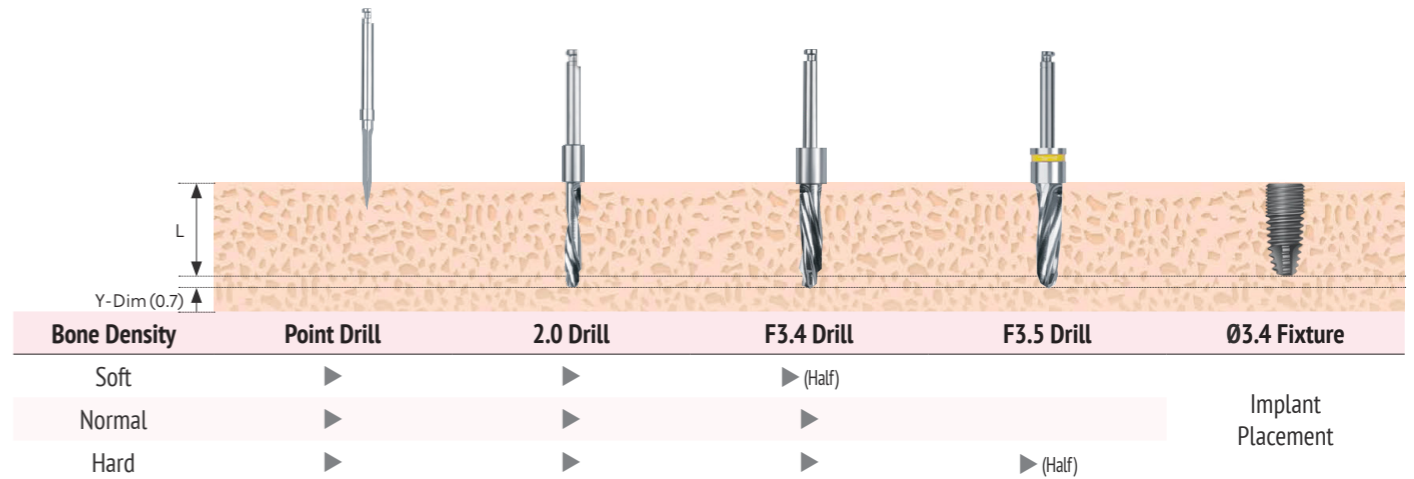

ASTFA 3.5 / FXAR 3.7 | Drilling Sequence

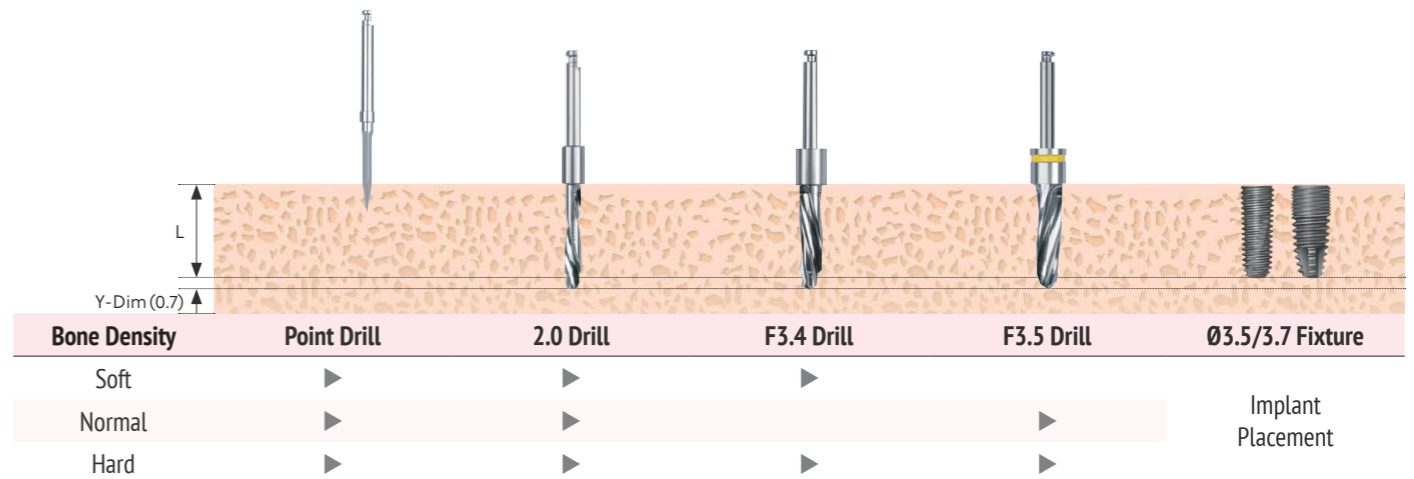

ASTFA 4.0 / FXAR 4.0 | Drilling Sequence

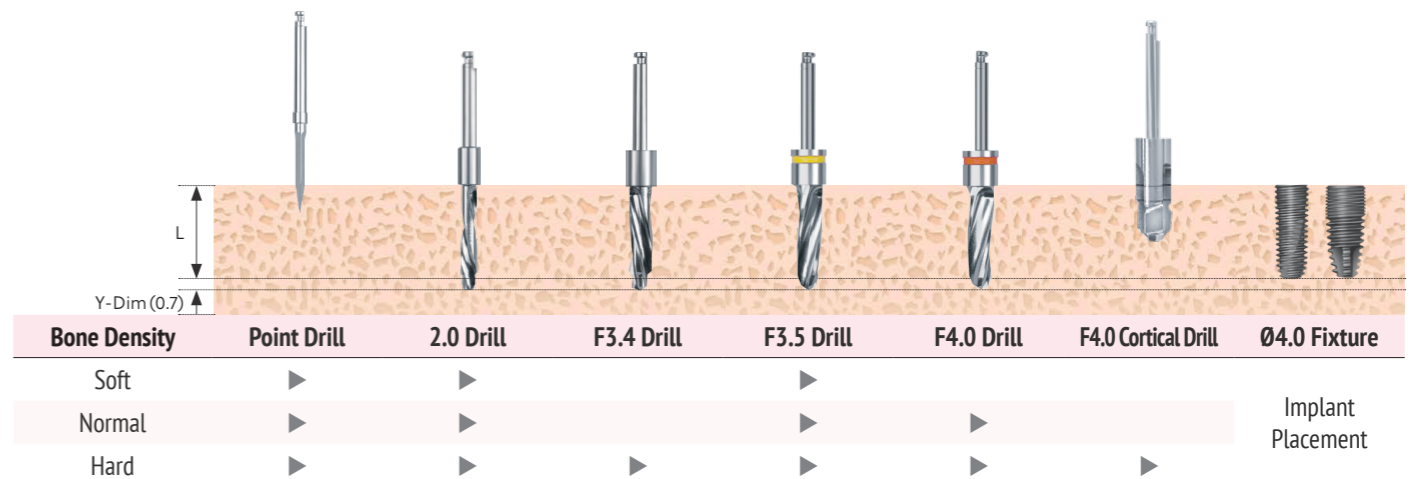

ASTFA 4.5 / FXAR 4.5 | Drilling Sequence

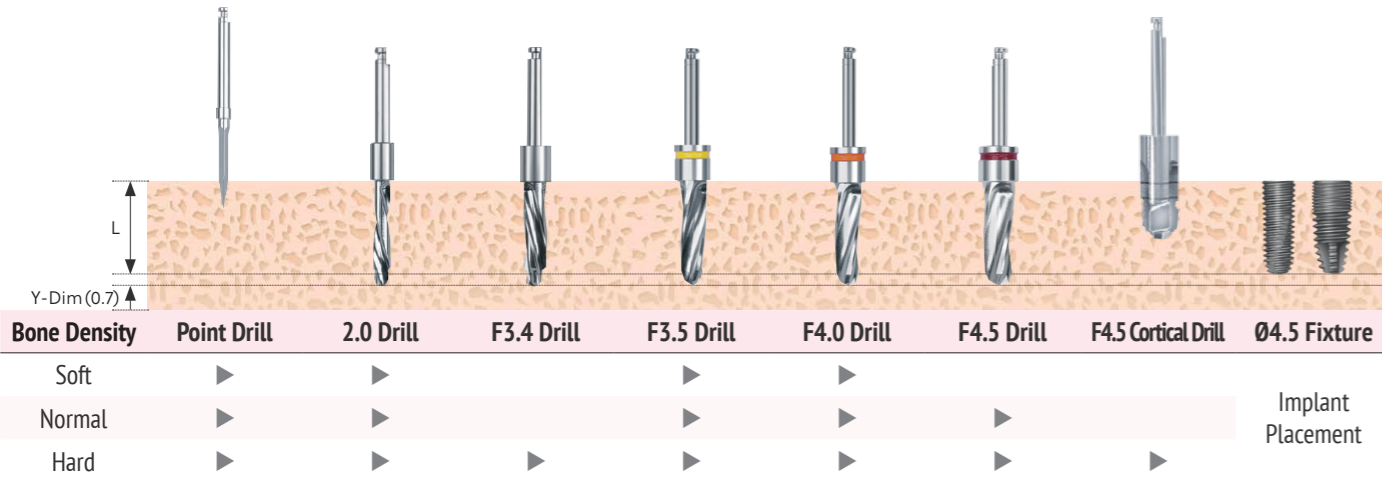

ASTFA 5.0 / FXAR 5.0 | Drilling Sequence

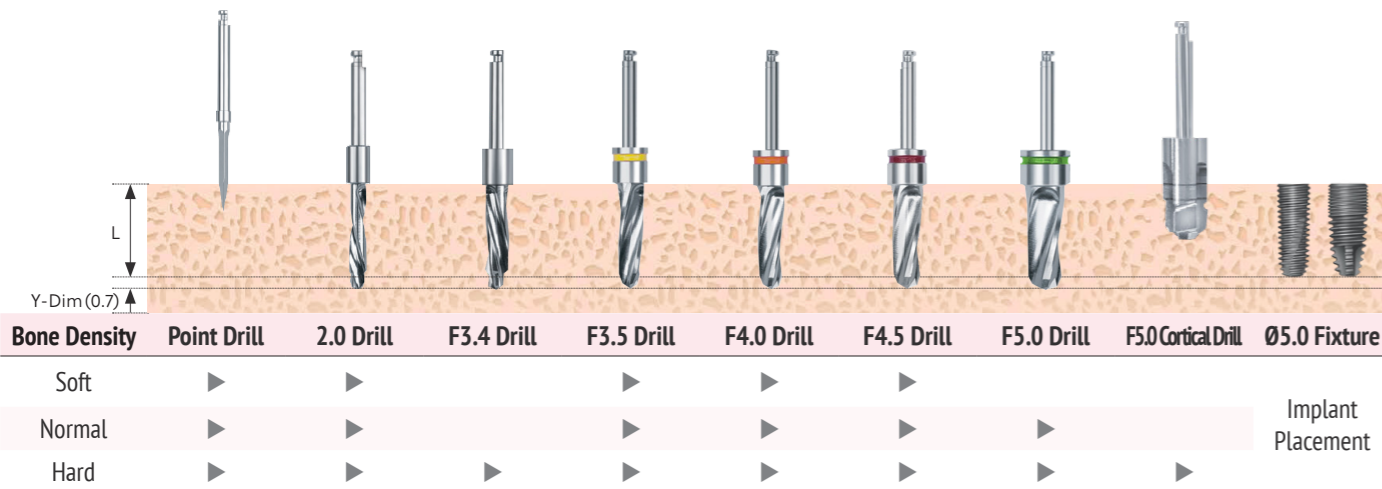

ASTFA 6.0 / FXAR 6.0 | Drilling Sequence

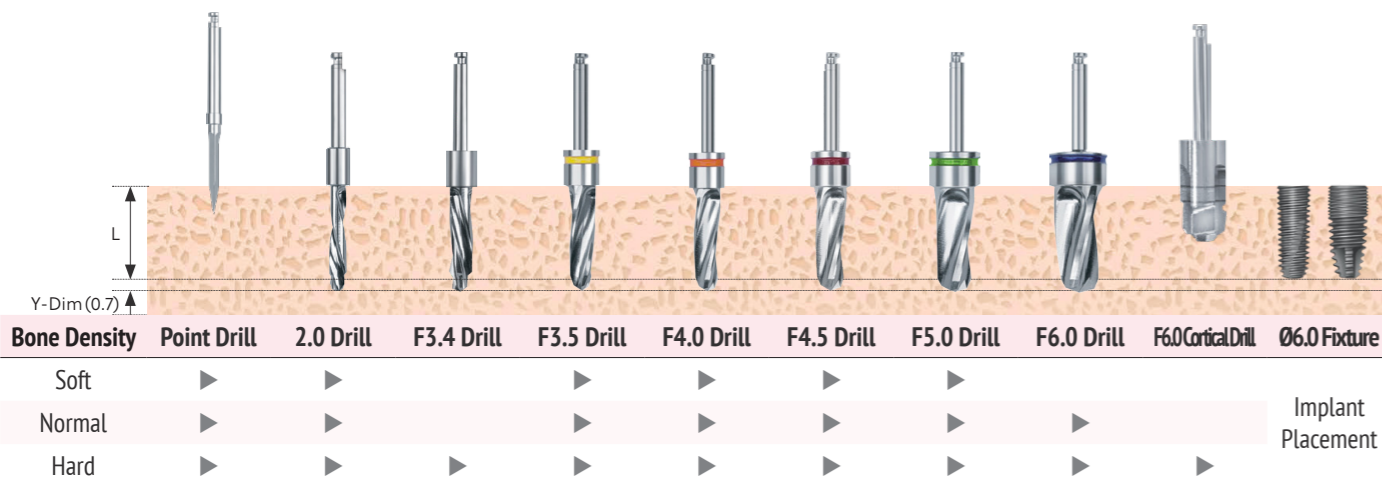

Non-Micro Thread AR Fixture | SLA

- No Mount System : Using a special fixture driver with more durability and easy separation-connection to fixture
- Surface : SLA
- Recommended placement torque : Less than 25~30N
- Tapered body for maxillary



D/L	7.5	8.5	10	11.5	13	15
D Ø3.5 Hex 2.1 N	ASTFA 3507 S	ASTFA 3508 S	ASTFA 3510 S	ASTFA 3511 S	ASTFA 3513 S	ASTFA 3515 S
D Ø4.0 Hex 2.5 R	ASTFA 4007 S	ASTFA 4008 S	ASTFA 4010 S	ASTFA 4011 S	ASTFA 4013 S	ASTFA 4015 S
D Ø4.5 Hex 2.5 R	ASTFA 4507 S	ASTFA 4508 S	ASTFA 4510 S	ASTFA 4511 S	ASTFA 4513 S	ASTFA 4515 S
D Ø5.0 Hex 2.5 W	ASTFA 5007 S	ASTFA 5008 S	ASTFA 5010 S	ASTFA 5011 S	ASTFA 5013 S	ASTFA 5015 S
D Ø6.0 Hex 2.5 W	ASTFA 6007 S	ASTFA 6008 S	ASTFA 6010 S	ASTFA 6011 S	ASTFA 6013 S	ASTFA 6015 S

Tapered AR Fixture | SLA

- Ø 4.0, Ø 5.0 fixture : Expanded Platform (Ø 3.4 fixture is excluded)
- No Mount System : Using a special fixture driver with more durability and easy separation-connection to fixture
- Surface : SLA
- Recommended placement torque : Less than 25~30N



D/L	7.5	8.5	10	11.5	13	15
D Ø3.4 Hex 2.1 N	FXAR 3407 TS	FXAR 3408 TS	FXAR 3410 TS	FXAR 3411 TS	FXAR 3413 TS	FXAR 3415 TS
D Ø3.7 Hex 2.5 R	FXAR 3707 TS	FXAR 3708 TS	FXAR 3710 TS	FXAR 3711 TS	FXAR 3713 TS	FXAR 3715 TS
D Ø4.0 Hex 2.5 R	FXAR 4007 TS	FXAR 4008 TS	FXAR 4010 TS	FXAR 4011 TS	FXAR 4013 TS	FXAR 4015 TS
D Ø4.5 Hex 2.5 R	FXAR 4507 TS	FXAR 4508 TS	FXAR 4510 TS	FXAR 4511 TS	FXAR 4513 TS	FXAR 4515 TS
D Ø5.0 Hex 2.5 W	FXAR 5007 TS	FXAR 5008 TS	FXAR 5010 TS	FXAR 5011 TS	FXAR 5013 TS	FXAR 5015 TS
D Ø6.0 Hex 2.5 W	FXAR 6007 TS	FXAR 6008 TS	FXAR 6010 TS	FXAR 6011 TS	FXAR 6013 TS	-

Cover Screw

- Using a 1.2 Hex Driver
- Fastening torque : 5~8Ncm



N	R W
CSA 2800 M	CSA 3300 S

Healing Abutment

- Using a 1.2 Hex Driver
- Fastening torque : 5~8Ncm
- H=From Fixture platform to top

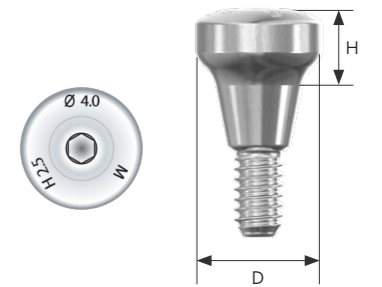

D/H	2.5	3	4	5	7	9
D Ø4.0 N	HAA 402 M	HAA 403 M		HAA 405 M	HAA 407 M	HAA 409 M
D Ø5.0 N	HAA 502 TM	HAA 503 TM	HAA 504 TM	HAA 505 TM	HAA 507 TM	HAA 509 TM
D Ø6.0 N	HAA 602 TM	HAA 603 TM	HAA 604 TM	HAA 605 TM	HAA 607 TM	HAA 609 TM
D Ø4.0 R W	HAA 402 S	HAA 403 S		HAA 405 S	HAA 407 S	HAA 409 S
D Ø5.0 R W	HAA 502 T	HAA 503 T	HAA 504 T	HAA 505 T	HAA 507 T	HAA 509 T
D Ø6.0 R W	HAA 602 T	HAA 603 T	HAA 604 T	HAA 605 T	HAA 607 T	HAA 609 T
D Ø7.0 R W	HAA 702 T	HAA 703 T	HAA 704 T	HAA 705 T	HAA 707 T	HAA 709 T

Solid / Cemented Abutment Level Impression

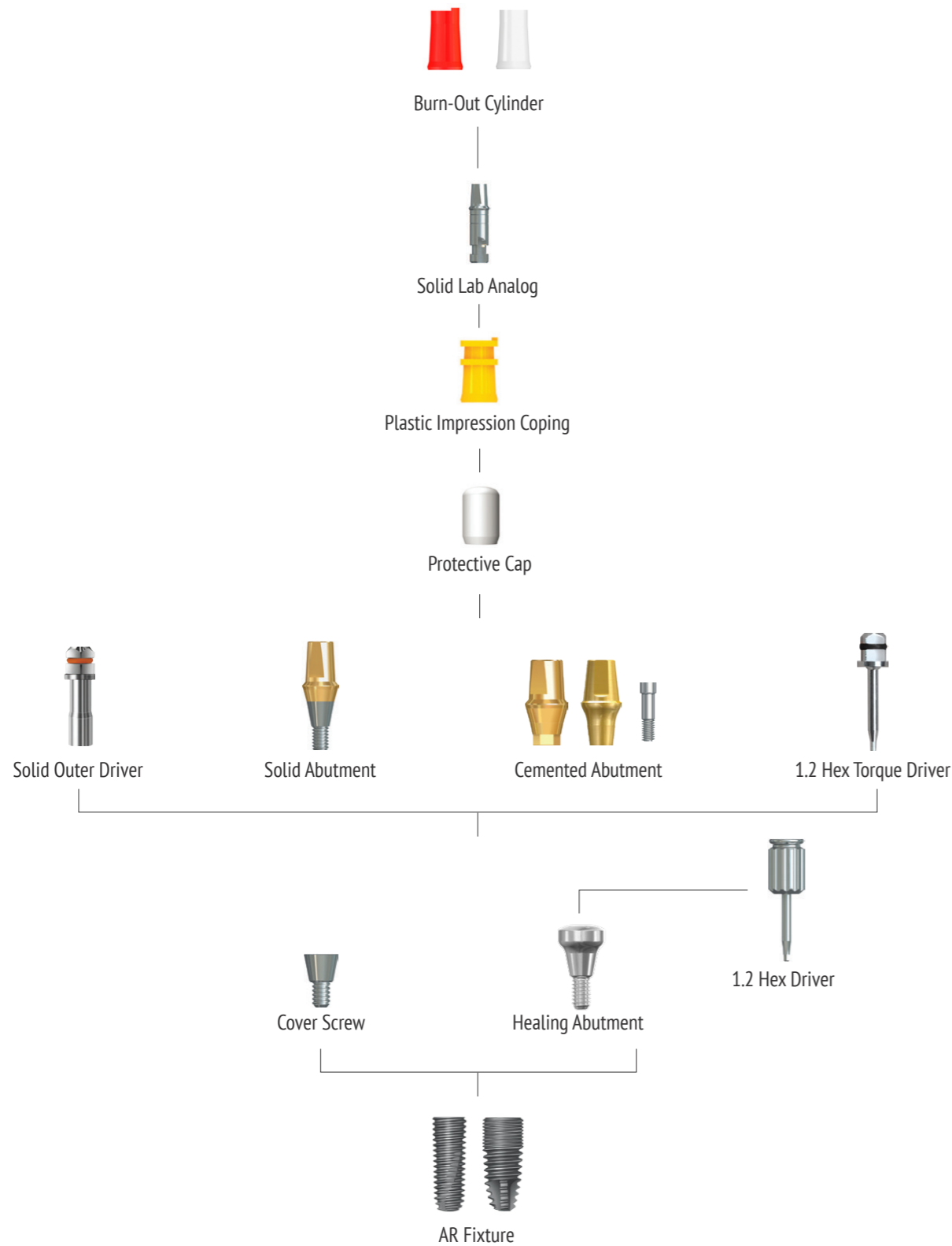

Solid Abutment

- An abutment combined with a set screw, for a bridge prosthesis
- Using a 1.2 Hex Driver
- Fastening torque : Narrow 20Ncm
Regular / Wide 30Ncm
- Protective cap included except Ø 4.0

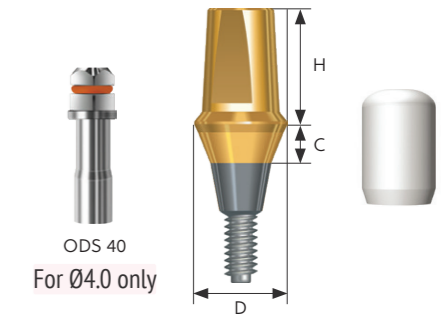

D/C		1	2	3	4	5	6
D Ø4.0 N	H 7.0	SAAS 3417 M	SAAS 3427 M	SAAS 3437 M	SAAS 3447 M		
Outer Driver		ODS 40					
D Ø4.5 N	H 4.0	SAAS 30514 MP	SAAS 30524 MP	SAAS 30534 MP	SAAS 30544 MP		
	H 5.5	SAAS 30515 MP	SAAS 30525 MP	SAAS 30535 MP	SAAS 30545 MP		
	H 7.0	SAAS 30517 MP	SAAS 30527 MP	SAAS 30537 MP	SAAS 30547 MP		
D Ø5.5 N	H 7.0	SAAS 30617 MP	SAAS 30627 MP	SAAS 30637 MP	SAAS 30647 MP		
D Ø4.5 R W	H 4.0	SAAS 45514 P	SAAS 45524 P	SAAS 45534 P	SAAS 45544 P		
	H 5.5	SAAS 45515 P	SAAS 45525 P	SAAS 45535 P	SAAS 45545 P	SAAS 45555 P	SAAS 45565 P
	H 7.0	SAAS 45517 P	SAAS 45527 P	SAAS 45537 P	SAAS 45547 P		
D Ø5.5 R W	H 4.0	SAAS 55614 P	SAAS 55624 P	SAAS 55634 P	SAAS 55644 P		
	H 5.5	SAAS 55615 P	SAAS 55625 P	SAAS 55635 P	SAAS 55645 P	SAAS 55655 P	SAAS 55665 P
	H 7.0	SAAS 55617 P	SAAS 55627 P	SAAS 55637 P	SAAS 55647 P		
D Ø6.5 R W	H 4.0	SAAS 65714 P	SAAS 65724 P	SAAS 65734 P	SAAS 65744 P		
	H 5.5	SAAS 65715 P	SAAS 65725 P	SAAS 65735 P	SAAS 65745 P	SAAS 65755 P	SAAS 65765 P
	H 7.0	SAAS 65717 P	SAAS 65727 P	SAAS 65737 P	SAAS 65747 P		

Protective Cap

- Solid Abutment protection with reduced patient discomfort
- Used as a temporary crown base



D/H	4	5.5	7
D Ø4.0	HCA 4004	HCA 4005	HCA 4007
D Ø4.5	HCA 4504	HCA 4505	HCA 4507
D Ø5.5	HCA 5504	HCA 5505	HCA 5507
D Ø6.5	HCA 6504	HCA 6505	HCA 6507

Cemented/ Angled / Milling / Temporary Fixture Level Impression

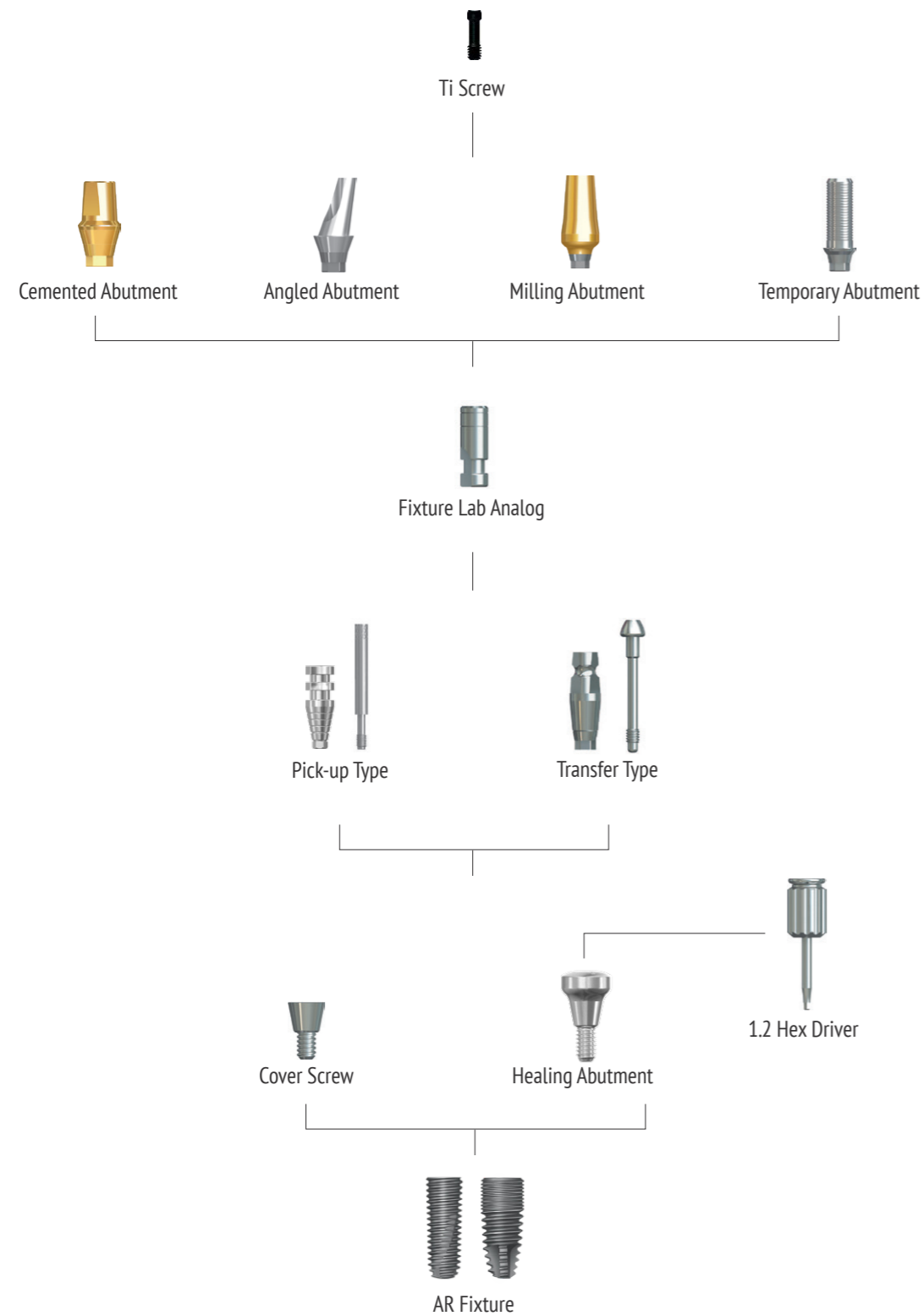

Cemented Abutment (Hex)

- An abutment for a single prosthesis.
- Using a 1.2 Hex Driver
- Fastening torque : Narrow 20Ncm
Regular / Wide 30Ncm
- Protect cap is optional

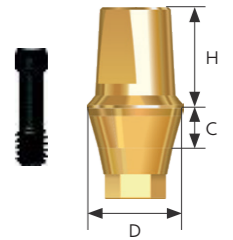

D/C		1	2	3	4	5	6
D Ø4.5 N	H 4.0	SAAT 30514 MSA	SAAT 30524 MSA	SAAT 30534 MSA	SAAT 30544 MSA		
	H 5.5	SAAT 30515 MSA	SAAT 30525 MSA	SAAT 30535 MSA	SAAT 30545 MSA		
	H 7.0	SAAT 30517 MSA	SAAT 30527 MSA	SAAT 30537 MSA	SAAT 30547 MSA		
Screw	Abutment Screw M 1.6 (AAHS 1687 Gold)						
D Ø4.5 R W	H 4.0	SAAT 45514 SA	SAAT 45524 SA	SAAT 45534 SA	SAAT 45544 SA		
	H 5.5	SAAT 45515 SA	SAAT 45525 SA	SAAT 45535 SA	SAAT 45545 SA	SAAT 45555 SA	SAAT 45565 SA
	H 7.0	SAAT 45517 SA	SAAT 45527 SA	SAAT 45537 SA	SAAT 45547 SA	SAAT 45557 SA	SAAT 45567 SA
Screw	Abutment Screw M 2.0 (AAHS 2083 Ebony)						
D Ø5.5 R W	H 4.0	SAAT 55614 SA	SAAT 55624 SA	SAAT 55634 SA	SAAT 55644 SA		
	H 5.5	SAAT 55615 SA	SAAT 55625 SA	SAAT 55635 SA	SAAT 55645 SA	SAAT 55655 SA	SAAT 55665 SA
	H 7.0	SAAT 55617 SA	SAAT 55627 SA	SAAT 55637 SA	SAAT 55647 SA	SAAT 55657 SA	SAAT 55667 SA
Screw	Abutment Screw M 2.0 (AAHS 2083 Ebony)						
D Ø6.5 R W	H 4.0	SAAT 65714 SA	SAAT 65724 SA	SAAT 65734 SA	SAAT 65744 SA		
	H 5.5	SAAT 65715 SA	SAAT 65725 SA	SAAT 65735 SA	SAAT 65745 SA	SAAT 65755 SA	SAAT 65765 SA
	H 7.0	SAAT 65717 SA	SAAT 65727 SA	SAAT 65737 SA	SAAT 65747 SA	SAAT 65757 SA	SAAT 65767 SA
Screw	Abutment Screw M 2.0 (AAHS 2083 Ebony)						

Cemented Abutment (Non-Hex)

- An abutment for a bridge prosthesis
- Using a 1.2 Hex Driver
- Fastening torque : Narrow 20Ncm
Regular / Wide 30Ncm
- Protect cap is optional

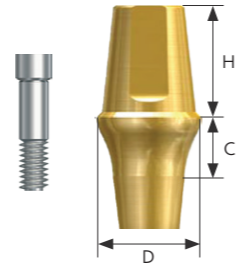

D/C	1	2	3	4	5	6
D Ø4.5 N	H 7.0	SAAT 30517 MNS	SAAT 30527 MNS	SAAT 30537 MNS	SAAT 30547 MNS	
Screw	Abutment Screw M 1.6 (AAHS 1610)					
	H 4.0	SAAT 45514 NS	SAAT 45524 NS	SAAT 45534 NS	SAAT 45544 NS	
D Ø4.5 R W	H 5.5	SAAT 45515 NS	SAAT 45525 NS	SAAT 45535 NS	SAAT 45545 NS	SAAT 45555 NS SAAT 45565 NS
Screw	Abutment Screw M 2.0 (AAHS 2010)					
	H 4.0	SAAT 55614 NS	SAAT 55624 NS	SAAT 55634 NS	SAAT 55644 NS	
D Ø5.5 R W	H 5.5	SAAT 55615 NS	SAAT 55625 NS	SAAT 55635 NS	SAAT 55645 NS	SAAT 55655 NS SAAT 55665 NS
Screw	Abutment Screw M 2.0 (AAHS 2010)					
	H 4.0	SAAT 65714 NS	SAAT 65724 NS	SAAT 65734 NS	SAAT 65744 NS	
D Ø6.5 R W	H 5.5	SAAT 65715 NS	SAAT 65725 NS	SAAT 65735 NS	SAAT 65745 NS	SAAT 65755 NS SAAT 65765 NS
Screw	Abutment Screw M 2.0 (AAHS 2010)					
	H 7.0	SAAT 65717 NS	SAAT 65727 NS	SAAT 65737 NS	SAAT 65747 NS	
Screw	Abutment Screw M 2.0 (AAHS 2010)					

Milling Abutment (Hex)

- Using a 1.2 Hex Driver
- Fastening torque : Narrow 20Ncm
Regular / Wide 30Ncm
- H = 10mm (MAA654S = 8mm)
- Used for adjusting the margin shape of abutment

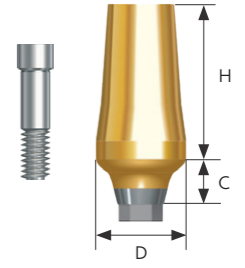

D/C	2	3	4
D Ø4.5 N	MAA 452 MS		
Screw	Abutment Screw M 1.6 (AAHS 1610)		
D Ø4.5 R W	MAA 452 S		
Screw	Abutment Screw M 2.0 (AAHS 2010)		
D Ø5.5 R W	MAA 552 S	MAA 553 S	
Screw	Abutment Screw M 2.0 (AAHS 2010)		
D Ø6.5 R W	MAA 652 S		MAA 654 S
Screw	Abutment Screw M 2.0 (AAHS 2010)		

Temporary Abutment (Hex)

- Fastening torque : Narrow 20Ncm
Regular / Wide 20~25Ncm
- H = 10mm

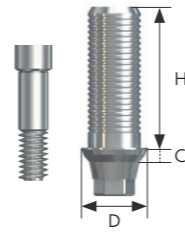

D/C	1	3
D Ø4.0 N	SATA 4010 SA	SATA 4030 SA
Screw	Abutment Screw M 1.6 (AAHS 1687)	
D Ø4.5 R W	SATA 4510 SA	SATA 4530 SA
Screw	Abutment Screw M 2.0 (AAHS 2083)	

Temporary Abutment (Non-Hex)

- Fastening torque : Narrow 20Ncm
Regular / Wide 20~25Ncm
- H = 10mm

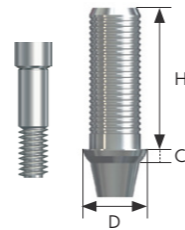

D/C	1	3
D Ø4.0 N	SATA 4010 NSA	SATA 4030 NSA
Screw	Abutment Screw M 1.6 (AAHS 1687)	
D Ø4.5 R W	SATA 4510 NSA	SATA 4530 NSA
Screw	Abutment Screw M 2.0 (AAHS 2083)	

Angled Abutment (Hex) A-Type

- Fastening torque : Narrow 20Ncm
Regular / Wide 30Ncm
- H = 7mm

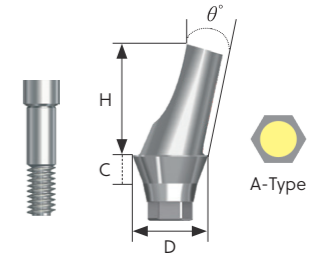

D/C		1	2	3	4
D Ø4.5 N	$\theta^{\circ} 15^{\circ}$	AAAT 45115 QAS	AAAT 45215 QAS	AAAT 45315 QAS	AAAT 45415 QAS
	$\theta^{\circ} 25^{\circ}$	AAAT 45125 QAS	AAAT 45225 QAS	AAAT 45325 QAS	AAAT 45425 QAS
Screw		Abutment Screw M 1.6 (AAHS 1608A)			
D Ø5.5 N	$\theta^{\circ} 15^{\circ}$	AAAT 55115 QAS	AAAT 55215 QAS	AAAT 55315 QAS	AAAT 55415 QAS
	$\theta^{\circ} 25^{\circ}$	AAAT 55125 QAS	AAAT 55225 QAS	AAAT 55325 QAS	AAAT 55425 QAS
Screw		Abutment Screw M 1.6 (AAHS 1608A)			
D Ø5.0 R W	$\theta^{\circ} 15^{\circ}$	AAAT 50115 BAS	AAAT 50215 BAS	AAAT 50315 BAS	AAAT 50415 BAS
	$\theta^{\circ} 25^{\circ}$	AAAT 50125 BAS	AAAT 50225 BAS	AAAT 50325 BAS	AAAT 50425 BAS
Screw		Abutment Screw M 2.0 (AAHS 2008B)			
D Ø6.0 R W	$\theta^{\circ} 15^{\circ}$	AAAT 60115 BAS	AAAT 60215 BAS	AAAT 60315 BAS	AAAT 60415 BAS
	$\theta^{\circ} 25^{\circ}$	AAAT 60125 BAS	AAAT 60225 BAS	AAAT 60325 BAS	AAAT 60425 BAS
Screw		Abutment Screw M 2.0 (AAHS 2008B)			

Angled Abutment (Hex) B-Type

- Fastening torque : Narrow 20Ncm
Regular / Wide 30Ncm
- H = 7mm

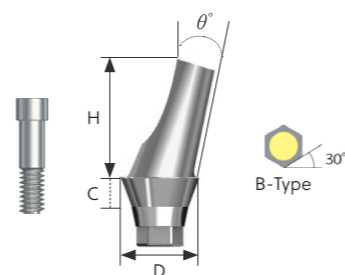

D/C		1	2	3	4
D Ø4.5 N	$\theta^{\circ} 15^{\circ}$	AAAT 45115 QBS	AAAT 45215 QBS	AAAT 45315 QBS	AAAT 45415 QBS
	$\theta^{\circ} 25^{\circ}$	AAAT 45125 QBS	AAAT 45225 QBS	AAAT 45325 QBS	AAAT 45425 QBS
Screw		Abutment Screw M 1.6 (AAHS 1608A)			
D Ø5.5 N	$\theta^{\circ} 15^{\circ}$	AAAT 55115 QBS	AAAT 55215 QBS	AAAT 55315 QBS	AAAT 55415 QBS
	$\theta^{\circ} 25^{\circ}$	AAAT 55125 QBS	AAAT 55225 QBS	AAAT 55325 QBS	AAAT 55425 QBS
Screw		Abutment Screw M 1.6 (AAHS 1608A)			
D Ø5.0 R W	$\theta^{\circ} 15^{\circ}$	AAAT 50115 BBS	AAAT 50215 BBS	AAAT 50315 BBS	AAAT 50415 BBS
	$\theta^{\circ} 25^{\circ}$	AAAT 50125 BBS	AAAT 50225 BBS	AAAT 50325 BBS	AAAT 50425 BBS
Screw		Abutment Screw M 2.0 (AAHS 2008B)			
D Ø6.0 R W	$\theta^{\circ} 15^{\circ}$	AAAT 60115 BBS	AAAT 60215 BBS	AAAT 60315 BBS	AAAT 60415 BBS
	$\theta^{\circ} 25^{\circ}$	AAAT 60125 BBS	AAAT 60225 BBS	AAAT 60325 BBS	AAAT 60425 BBS
Screw		Abutment Screw M 2.0 (AAHS 2008B)			

Angled Abutment (Non-Hex)

- Fastening torque : Narrow 20Ncm
Regular / Wide 30Ncm
- H = 7mm

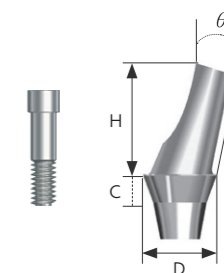

D/C		2	4
D Ø5.0 R W	$\theta^{\circ} 15^{\circ}$	AAAT 50215 BNS	AAAT 50415 BNS
	$\theta^{\circ} 25^{\circ}$	AAAT 50225 BNS	AAAT 50425 BNS
Screw		Abutment Screw M 2.0 (AAHS 2008B)	
D Ø6.0 R W	$\theta^{\circ} 15^{\circ}$	AAAT 60215 BNS	AAAT 60415 BNS
	$\theta^{\circ} 25^{\circ}$	AAAT 60225 BNS	AAAT 60425 BNS
Screw		Abutment Screw M 2.0 (AAHS 2008B)	

Ti-base Abutment

- Used for producing Ti + Zr custom abutment with CAD/CAM equipment
- H = 4mm

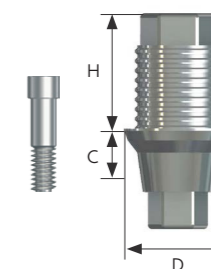

C/D	Ø 4.0	Ø 4.5
1.2	Tibs-011MSA	Tibs-012SA
Screw	Abutment Screw M 1.6 (AAHS 1687)	Abutment Screw M 2.0 (AAHS 2083)

Transfer Impression Coping (Hex)

- A Transfer type with utilizing a close tray
- Packing unit : Impression coping body+Guide Pin
- Hex Type

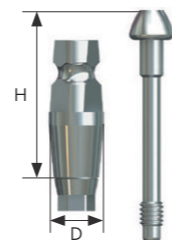

D/H	11(Short)	14 (Long)
D Ø4.0 N	IAT 4011 MS	IAT 4014 MS
Pin	GTA 1617 M	GTA 1620 M
D Ø4.0 R W	IAT 4011 SS	IAT 4014 SS
Pin	GTA 2017 S	GTA 2020 S
D Ø5.0 R W	IAT 5011 SS	IAT 5014 SS
Pin	GTA 2017 S	GTA 2020 S
D Ø6.0 R W	IAT 6011 SS	IAT 6014 SS
Pin	GTA 2017 S	GTA 2020 S

Transfer Impression Coping (Non-Hex)

- A Transfer type with utilizing a close tray
- Packing unit : Impression coping body+Guide Pin
- Non-Hex Type

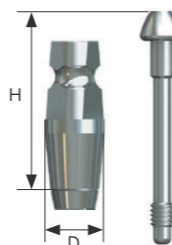

D/H	11(Short)	14 (Long)
D Ø4.0 N	IAT 4011 MNS	IAT 4014 MNS
Pin	GTA 1617 M	GTA 1620 M
D Ø4.0 R W	IAT 4011 SNS	IAT 4014 SNS
Pin	GTA 2017 S	GTA 2020 S
D Ø5.0 R W	IAT 5011 SNS	IAT 5014 SNS
Pin	GTA 2017 S	GTA 2020 S
D Ø6.0 R W	IAT 6011 SNS	IAT 6014 SNS
Pin	GTA 2017 S	GTA 2020 S

Pick-up Impression Coping (Hex)

- A Pick-up type with utilizing a custom tray.
- Increasing convenience with being composed of Short & Long

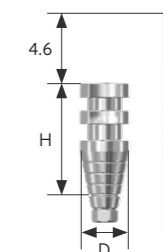

D/H	10(Short)	14 (Long)
D Ø4.0 N	IPA 3010S	IPA 3013 S
D Ø4.5 N	IPA 3410 S	IPA 3413 S
Pin	GPA 1613	GPA 1617
D Ø4.5 R W	IPA 4810 S	IPA 4813 S
Pin	GPA 2013	GPA 2017
D Ø5.5 R W	IPA 5810 S	IPA 5813 S
Pin	GPA 2013	GPA 2017
D Ø6.5 R W	IPA 6810 S	IPA 6813 S
Pin	GPA 2013	GPA 2017
D Ø6.5 R W	IPA 6810 TS	IPA 6813 TS
Pin	GPA 2013	GPA 2017

Pick-up Impression Coping (Non-Hex)

- A Pick-up type with utilizing a custom tray.
- Increasing convenience with being composed of Short & Long

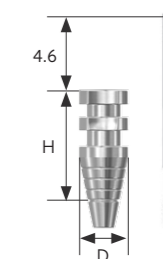

D/H	10(Short)	14 (Long)
D Ø4.0 N	IPA 3010 NS	IPA 3013 NS
D Ø4.5 N	IPA 3410 NS	IPA 3413 NS
Pin	GPA 1613	GPA 1617
D Ø4.5 R W	IPA 4810 NS	IPA 4813 NS
Pin	GPA 2013	GPA 2017
D Ø5.5 R W	IPA 5810 NS	
Pin	GPA 2013	

Plastic Impression Coping

- Components for solid abutment impression
- Applicable for H (4, 5.5, 7)
- Used for transfer abutment (except Ø4.0)



D Ø4.5 N R	IPA 4510
D Ø5.5 R	IPA 5510
D Ø6.5 W	IPA 6510

Burn-Out Cylinder

- Replacement of resin cap before wax up using rigid abutment
- Enabling the production of elaborate prosthesis with uniform interior
- Used after casting, after cleaning the margin for proper fitting



	Single	Bridge
D Ø4.5 N R	PCA 4510	PCA 4510 N
D Ø5.5 R	PCA 5510	PCA 5510 N
D Ø6.5 W	PCA 6510	PCA 6510 N

Fixture Lab Analog

- Lab analog for fixture level impression
- L = 15mm
- LAAF 3715 = Only for Tapered AR Fixture

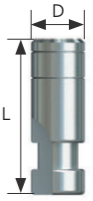

D Ø3.4 N	LAAF 3415 (One line)
D Ø3.7 R	LAAF 3715 (Three lines)
D Ø4.0 / Ø4.5 R	LAAF 4015 (Two lines)
D Ø5.0 / Ø6.0 W	LAAF 4015 (Two lines)

Solid Lab Analog

- Integrated type of abutment & analog

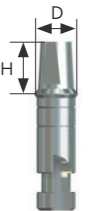

D/H	4	5.5	7
D Ø4.5 N R	LAAS 4504 L	LAAS 4505 L	LAAS 4507 L
D Ø5.5 R	LAAS 5504 L	LAAS 5505 L	LAAS 5507 L
D Ø6.5 W	LAAS 6504 L	LAAS 6505 L	LAAS 6507 L

Multi / Multi Angled Abutment Level Impression

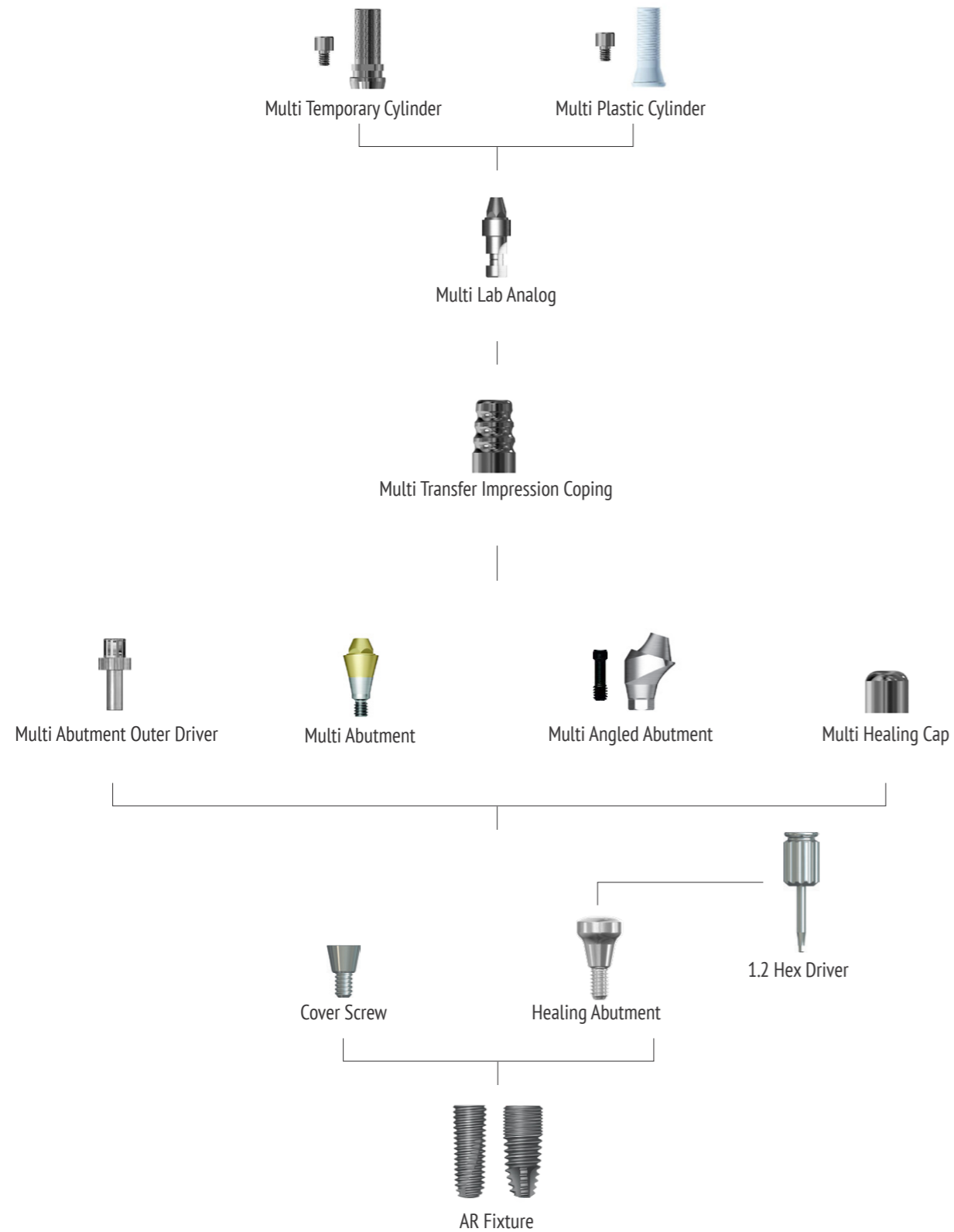

Multi Angled Abutment (All-on-4)

- Used in implant path compensation in screw retained multiple case
- Up to 60° path compensation (two implant standard)
- Recommended tightening torque : 20Ncm(Narrow), 30Ncm(regular)

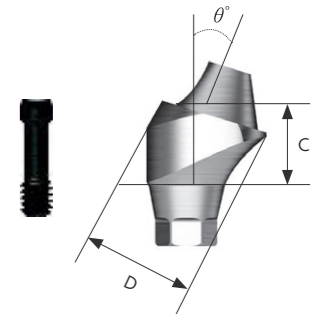

D/C		2.5	3.0	3.5	4.0	5.0
D Ø4.8 N	θ 17°	AMA 174825 MS	AMA 174830 MS		AMA 174840 MS	
	θ 30°			AMA 304835 MS	AMA 304840 MS	AMA 304850 MS
Screw		AMASM				
D Ø4.8 R	θ 17°	AMA 174825 S	AMA 174830 S		AMA 174840 S	
	θ 30°			AMA 304835 S	AMA 304840 S	AMA 304850 S
Screw		AMASR				

Multi Abutment

- Uses specialized outer driver (AMOD)
- Used in screw type prosthetics in multiple cases
- Recommended tightening torque : 30Ncm

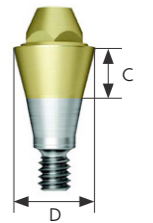

D/C	1.0	2.0	3.0	4.0
D Ø4.8 N	AM 4810 M	AM 4820 M	AM 4830 M	AM 4840 M
	AM 4810	AM 4820	AM 4830	AM 4840
D Ø4.8 R				

Multi Temporary Cylinder

- Used in producing temporary prosthetic with multi abutment (Material: Ti Gr-5)
- Structure allows for easy customization and minimization of indication constraints
- 1.2 hex driver
- Recommended tightening torque : 20Ncm
- Packing unit : cylinder + Ti screw

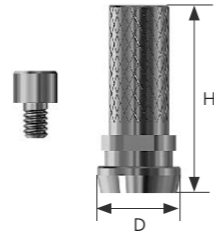

D/H	12
D Ø4.8 N R	AMTC 48 N
Screw	AMCS14

Multi Transfer Impression Coping

- Takes impression using closed tray

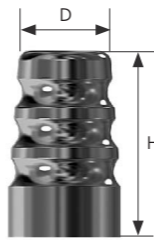

D/H	8
D Ø4.8 N R	AMTI 48

Multi Lab Analog

- Achieves Multi abutment of the oral cavity on a working model



D Ø4.8 N R	AMLA 48
---------------	---------

Multi Healing Cap

- Used when protecting multi abutment in the oral cavity and minimizing foreign body sensation in patient
- 1.2 hex driver
- Recommended tightening torque : 20Ncm

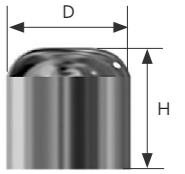

D/H	4.8
D Ø4.8 N R	AMHC 48

Multi Plastic Cylinder

- Produces prosthetics by casting with dental-grade alloy (gold, non-precious metals)
- Connection region's precision is reduced compared to gold cylinder
- 1.2 hex driver
- Recommended tightening torque : 20Ncm
- Packing unit : cylinder + Ti screw

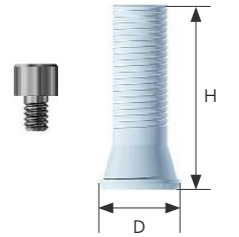

D/H	12
D Ø4.8 N R	AMPC 48 N
Screw	AMCS14

Multi Abutment Outer Driver

- Torque driver specialized for multi-abutments



AMOD

Locator / O-ring Overdenture

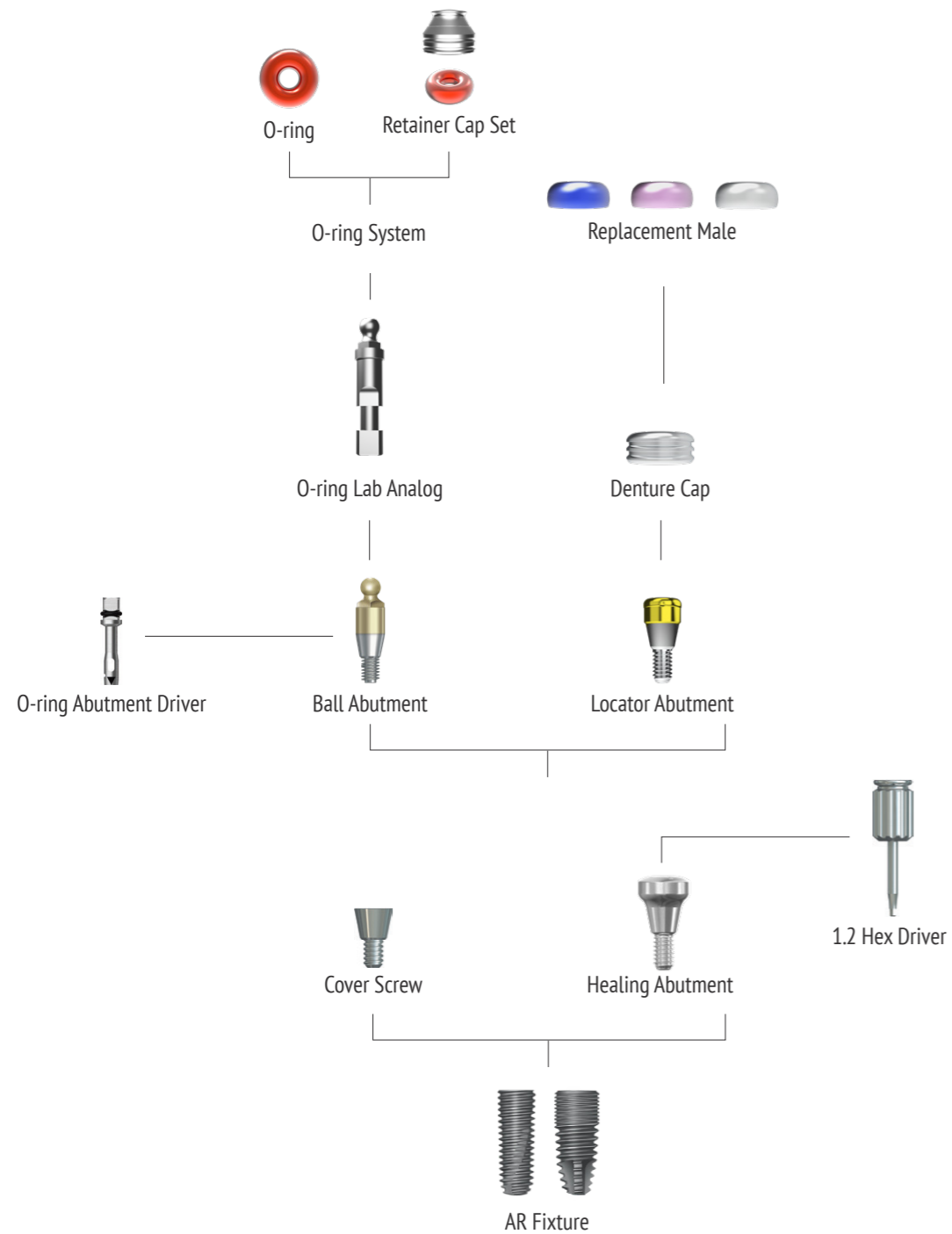

Locator Abutment (Narrow)

- Placement angle compensation up to 40°
- 1.5mm lower profile, attachment with various and stable retention forces
- Tightened with a dedicated driver
- Recommended tightening torque : 20Ncm

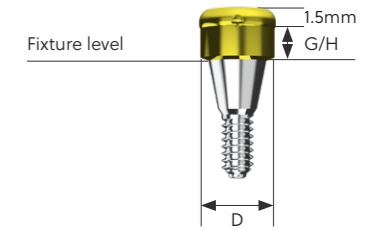

Code	D	G/H	Screw
BALCA 3510M	Ø 3.75	1.0	M1.6
BALCA 3520M	Ø 3.75	2.0	M1.6
BALCA 3530M	Ø 3.75	3.0	M1.6
BALCA 3540M	Ø 3.75	4.0	M1.6
BALCA 3550M	Ø 3.75	5.0	M1.6

Locator Abutment (Regular)

- Placement angle compensation up to 40°
- 1.5mm lower profile, attachment with various and stable retention forces
- Tightened with a dedicated driver
- Recommended tightening torque : 30Ncm

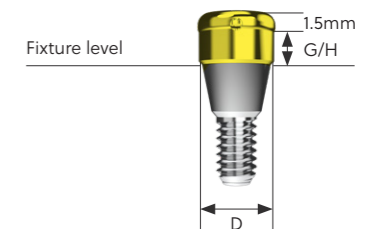

Code	D	G/H	Screw
BALCA 4010S	Ø 3.75	1.0	M2.0
BALCA 4020S	Ø 3.75	2.0	M2.0
BALCA 4030S	Ø 3.75	3.0	M2.0
BALCA 4040S	Ø 3.75	4.0	M2.0
BALCA 4050S	Ø 3.75	5.0	M2.0

Denture Cap

- Packing unit : Metal Replacement Male + Replacement Male (blue/pink/clear)



Code

BDCS

- Packing unit : Metal Replacement Male



Code

BDC

- Packing unit : Blue Replacement Male
- Retention Force : about 10±5N



Code

BLRMB

- Packing unit : Pink Replacement Male
- Retention Force : about 20±5N



Code

BLRMP

- Packing unit : Clear Replacement Male
- Retention Force : about 30±5N



Code

BLRMN

Ball Abutment

- Abutment with o-ring attachment for overdenture
- Placement angle compensation up to 20°
- Tightened with a dedicated outer driver
- Recommended tightening torque : 30Ncm (mini/regular)

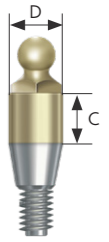

D/C	1	2	4
N	SABS4510M	SABS4520M	SABS4540M
R	SABS4510	SABS4520	SABS4540

Retainer Cap Set

- Packing unit : Retainer cap + O-ring



Code

BRCS

O-ring

- Packing unit : O-ring 1 piece



Code

BOR45R

O-ring Lab Analog

- Make Oral Ball abutments on the working model
- Packing unit : Lab analog



Code
MRBLA

O-ring Abutment Torque driver



Code	L	D
BOBTDS	Short	Ø 3.8
BOBTDL	Long	Ø 3.8

BIO?EM
DENTAL IMPLANT SYSTEM

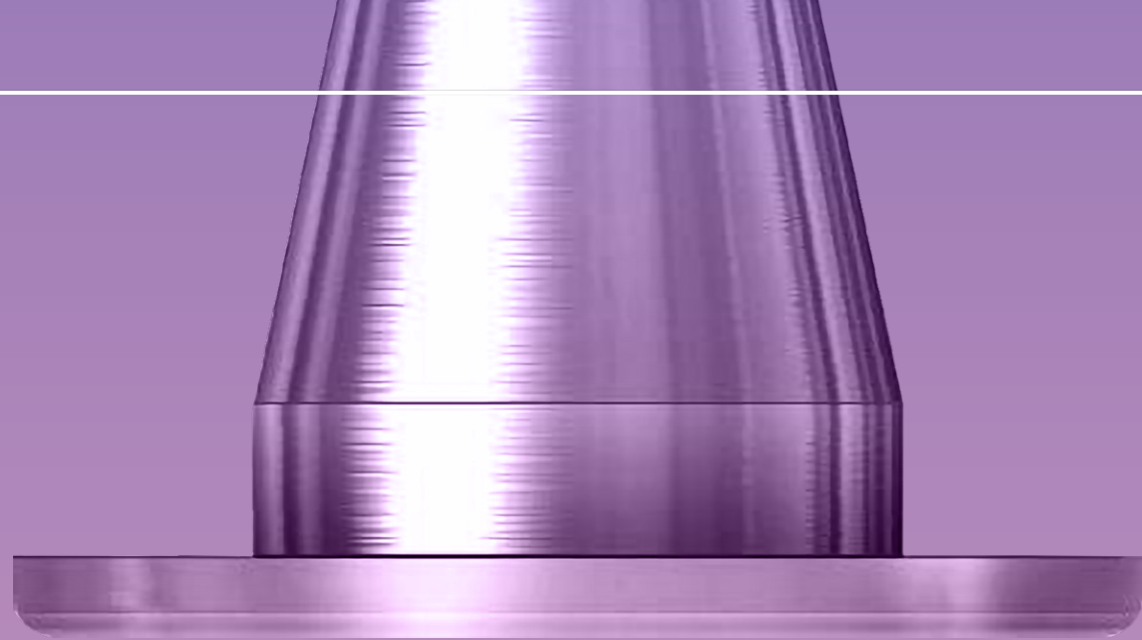

SANTA

BIOARK



SANTA & BIOARK

SANTA

- Specialized Tenting abutment for Simple 3D ridge augmentation
- Reducing edentulous healing period
- Reducing the number of surgery and postop complications
- No need to harvest bone block from different site

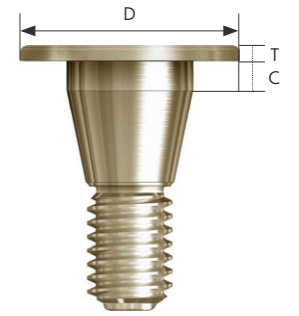

T/D	C	Ø 5.0	Ø 6.0
	1	S105	S106
0.4 mm	2	S205	S206
	3	S305	S306
3 mm	3	S335	S336



SANTA video link

BIOARK

- Hidden Space for Bone & Tissue Healing
- Easy Esthetic Implant Prosthetics
- Simple ingrowth of Soft Tissue & Bone
- Comfortable environment for Osteoblast

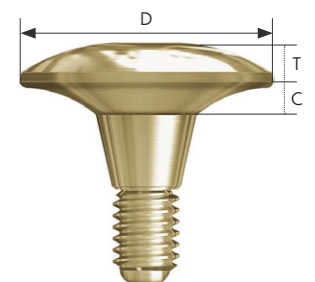

D	T	1.6	1.6	1.6	1.6
	C	1	3	5	7
Ø 5.5		A0553M	A0555M	A0557M	A0559M
Ø 7.2		A0723T	A0725T	A0727T	A0729T
Ø 7.6		A0763T	A0765T	A0767T	A0769T
Ø 8.1		A0813T	A0815T	A0817T	A0819T
Ø 9.0		A0903T	A0905T	A0907T	A0909T

IR | TISSUE LEVEL IMPLANT SYSTEM

BIOEM
DENTAL IMPLANT SYSTEM

IR Tissue Level Implant System	48
IR Prosthetic Flow Chart	49
FXIR 3.5 Drilling Sequence	50
FXIR 4.1 Drilling Sequence	50
FXIR 4.8 Drilling Sequence	51
FXIR 5.5 Drilling Sequence	51
IR Fixture SLA	52
Cover Screw	53
Healing Abutment	53
Solid Abutment	53
Wide Solid Abutment	54
Protective Cap	54
Com Octa Plus Abutment	55
Angled Abutment	55
Com Octa Plus Angled Abutment	55
Fixture Analog	56
Transfer Impression Coping	56
Pick-up Impression Coping	56
Solid Analog	57
Plastic Impression Coping	57
Burn-Out Cylinder	57

IR | Tissue Level Implant System

Single Pitch Thread

- 0.8pitch x 0.45depth x double thread Taper root
- Optimized design for RBM/SLA surface
- Reinforce fixture strength

Corkscrew Thread

- 0.8pitch x 0.45depth x double thread
- Powerful self threading
- High initial stability

Taper degree 1.5°

- Easy to get initial stability in soft bone



Straight Body

- Implantation performance
- Easy surgical protocol
- Decrease sensitivity on drill size

Apical

- High performance self-tapping
- High fixation

IR | Prosthetic Flow Chart

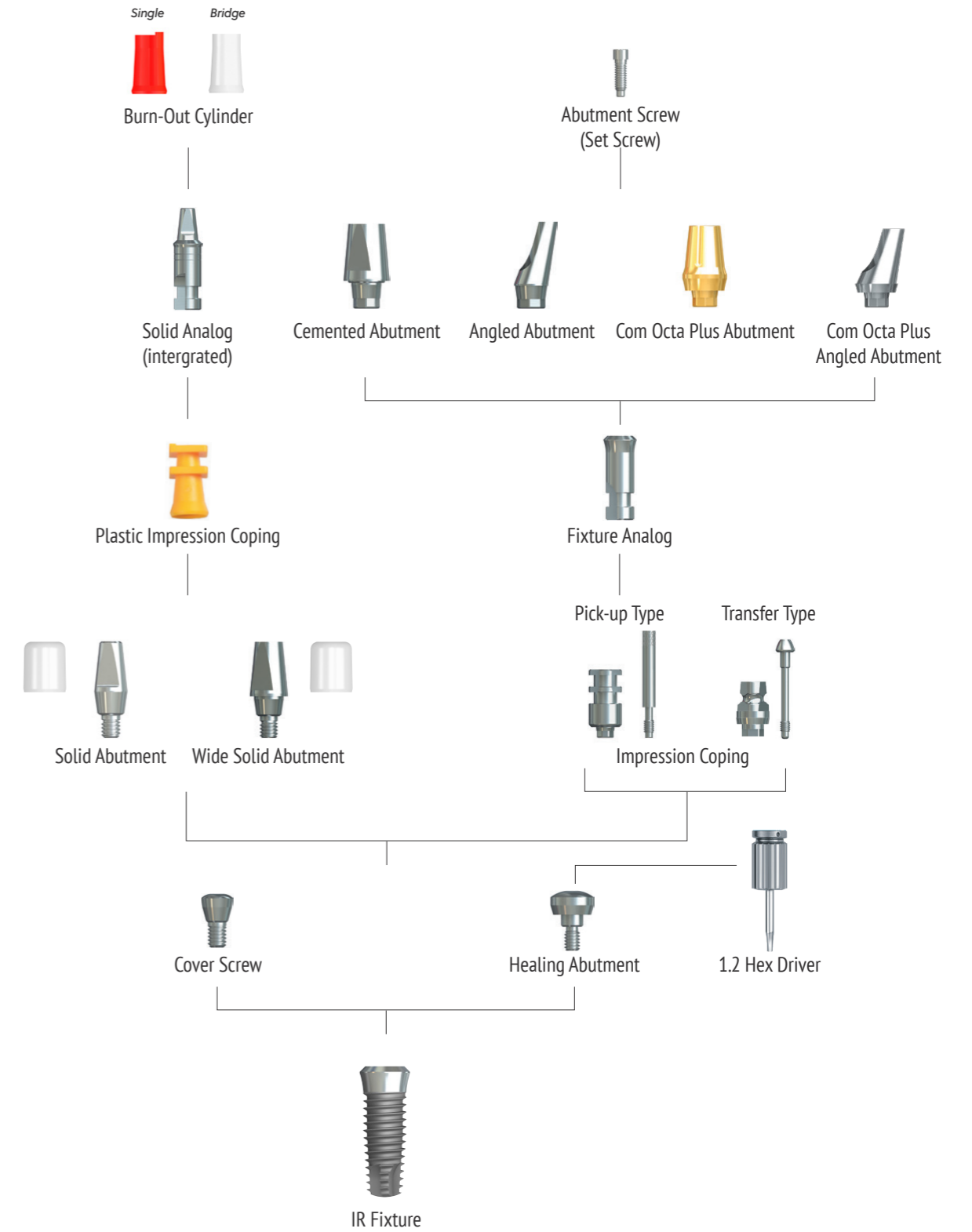

FXIR 3.5 | Drilling Sequence

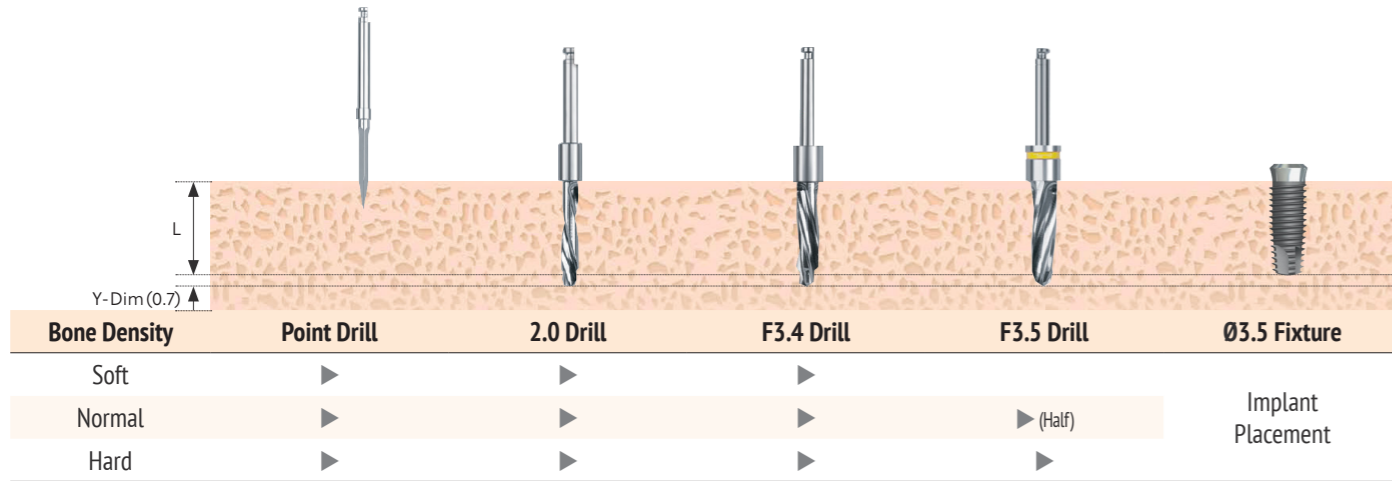

FXIR 4.8 | Drilling Sequence

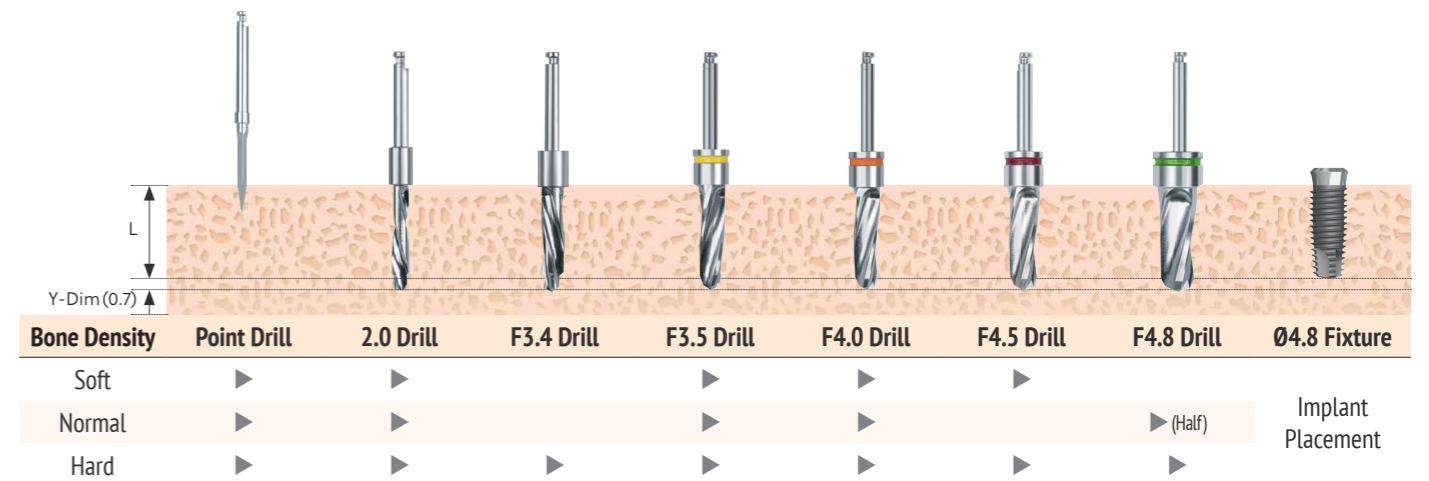

FXIR 4.1 | Drilling Sequence

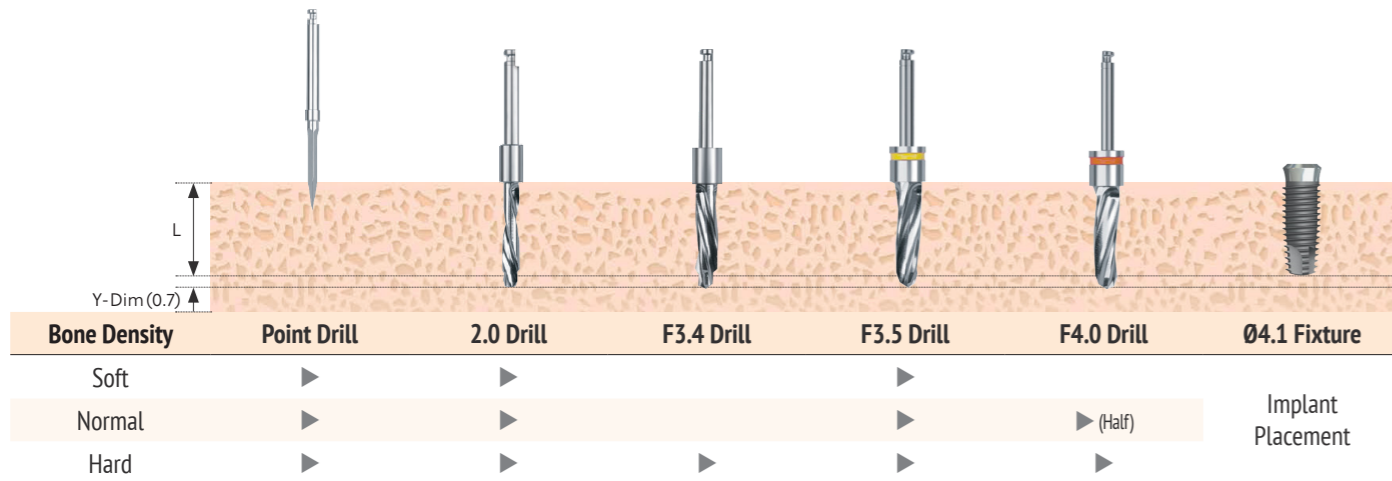

FXIR 5.5 | Drilling Sequence

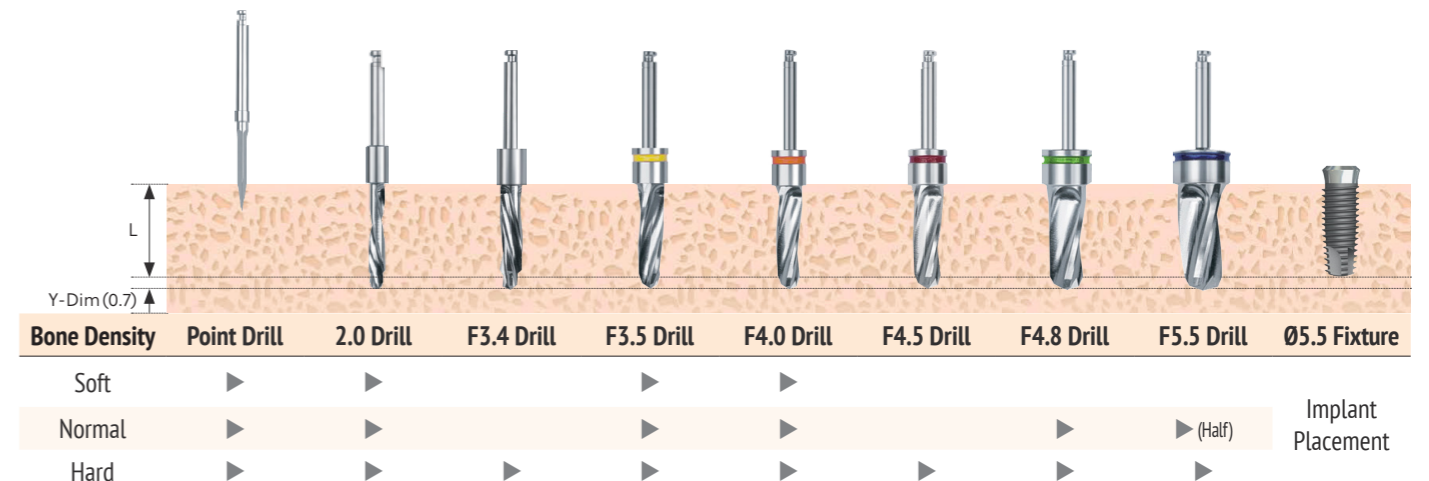

IR Fixture | SLA

- Machined Surface Cuff : Affinity with the gingival tissue and easy to manage plaques
- Recommended placement torque 25 ~ 30Ncm
- Surface : SLA
- No Mount System : Using a special fixture driver with more durability and easy separation-connection to fixture

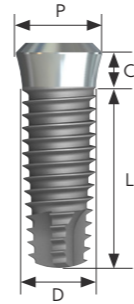

D/L	7.5	8.5	10	11.5	13	15	
P Ø4.8 (D Ø3.5) N 3.1 octa	C 1.8	FXIR 3508 MS	FXIR 3510 MS	FXIR 3511 MS	FXIR 3513 MS	FXIR 3515 MS	
P Ø4.8 (D Ø4.1) R 2.9 octa	C 1.8	FXIR 4007 MS	FXIR 4008 MS	FXIR 4010 MS	FXIR 4011 MS	FXIR 4013 MS	FXIR 4015 MS
	C 2.8	FXIR 4008 S	FXIR 4010 S	FXIR 4011 S	FXIR 4013 S	FXIR 4015 S	
P Ø4.8 (D Ø4.8) R 2.9 octa	C 1.8	FXIR 4807 MS	FXIR 4808 MS	FXIR 4810 MS	FXIR 4811 MS	FXIR 4813 MS	FXIR 4815 MS
	C 2.8	FXIR 4808 S	FXIR 4810 S	FXIR 4811 S	FXIR 4813 S	FXIR 4815 S	
P Ø6.0 (D Ø4.8) W 2.9 octa	C 2.0	FXIR 4807 WS	FXIR 4808 WS	FXIR 4810 WS	FXIR 4811 WS	FXIR 4813 WS	FXIR 4815 WS
P Ø6.0 (D Ø5.5) W 2.9 octa	C 2.0	FXIR 5507 S	FXIR 5508 S	FXIR 5510 S	FXIR 5511 S	FXIR 5513 S	FXIR 5515 S

Cover Screw

- Using in the case of the limited adjacent space or the insufficient gingival of the suture part
- Using 1.2 Hex Driver
- Fastening torque : 5~8Ncm



P Ø4.8 N R	CSI 4000
P Ø6.0 W neck	CSI 4805 W

Healing Abutment

- Using 1.2 Hex Driver
- Fastening torque : 5~8Ncm

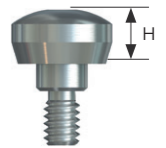

P/H	1.5	2.0	3.0	4.0	6.0
P Ø4.8 N R	HAI 48601	HAI 48602	HAI 48603	HAI 48604	HAI 48606
P Ø6.0 W neck	HAI 60701	HAI 60702		HAI 60704	HAI 60706

Solid Abutment

- Stable connection structure of 8 Morse Taper method
- Using for making the cement typed prosthesis
- Fastening torque : Narrow 20Ncm, Regular / Wide 30Ncm
- Protective cap included

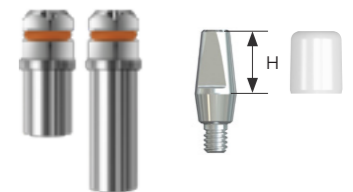

P/H	4.0	5.5	7.0
P Ø4.8 N R	SAIS 48354 P	SAIS 48355 P	SAIS 48357 P
Outer Driver		SDB 3508(Short)	SDB 3515(Long)

Wide Solid Abutment

- Stable connection structure of 8 Morse Taper method
- Using for making the cement typed prosthesis
- Fastening torque : Narrow 20Ncm
Regular / Wide 30Ncm
- Protective cap included

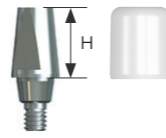

P/H	4.0	5.5	7.0
P Ø4.8 N R	SAIS 48434 P	SAIS 48435 P	SAIS 48437 P
P Ø6.0 W	SAIS 604 EWP	SAIS 605 EWP	SAIS 607 EWP

Protective Cap

- Solid Abutment protection with reduced patient discomfort
- Used as a temporary crown base



P/H	4.0	5.5	7.0
P Ø4.8 R	SIC 4804 S	SIC 4805 S	SIC 4807 S
P Ø4.8 W Wide Solid	SIC 4804 E	SIC 4805 E	SIC 4807 E
P Ø6.0 W Wide Solid	SIC 6004 W	SIC 6005 W	SIC 6007 W

Cemented Abutment

- Stable connection structure of 8 Morse Taper method
- Abutment for producing cement-retained/combination prosthesis
- Fastening torque : Narrow 20Ncm
Regular / Wide 30Ncm

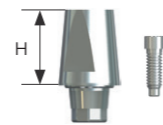

P/H	4.0	5.5	7.0
P Ø4.8 N	SAIT 40434 S	SAIT 40435 S	SAIT 40437 S
P Ø4.8 R	SAITB 40434 S	SAITB 40435 S	SAITB 40437 S
P Ø6.0 W	SAITB 604 EWS	SAITB 605 EWS	SAITB 607 EWS
Screw	Abutment Screw M 2.0 (ABHS 2008)		

Com Octa Plus Abutment

- Stable connection structure of 8 Morse Taper method
- Abutment for producing cement-retained/combination prosthesis
- Using for making the cement typed prosthesis
- Fastening torque : Narrow 20Ncm
Regular / Wide 30Ncm
- H = 6mm

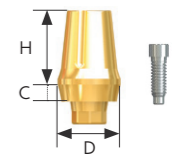

P/C	2	4
P Ø4.8 R D5.5	SAITB 4826 CS	SAITB 4846 CS
Screw	Abutment Screw M 2.0 (ABHS 2008)	
P Ø6.0 W D6.5	SAITB 6026 CS	SAITB 6046 CS
Screw	Abutment Screw M 2.0 (ABHS 2008)	

Angled Abutment

- Using for making the cement typed prosthesis
- Fastening torque : Narrow 20Ncm
Regular / Wide 30Ncm

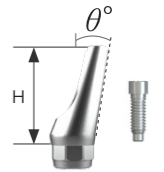

P/θ°	θ° 15°	θ° 25°
P Ø4.8 N	AAIT 35415 S	AAIT 35425 S
Screw	Abutment Screw M 2.0 (AIHS 2006)	
P Ø4.8 R	AAITB 35415 S	AAITB 35425 S
Screw	Abutment Screw M 2.0 (AIHS 2006)	
P Ø6.0 W	AAITB 6015 WS	AAITB 6025 WS
Screw	Abutment Screw M 2.0 (AIHS 2006)	

Com Octa Plus Angled Abutment

- H = 7mm

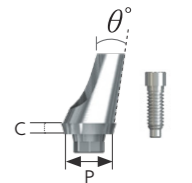

P/θ°	C	θ° 15°	θ° 25°
P Ø4.8 R	1	AAITB 35115 CS	AAITB 35125 CS
	2	AAITB 35215 CS	AAITB 35225 CS
Screw	Abutment Screw M 2.0 (AIHS 2006)		

Fixture Analog

- Lab analog for fixture level impression
- An integrated Lab Analog of Abutment & Analog

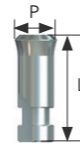

P/L	15
P Ø4.8 N	LAIF 4815 M
P Ø4.8 R	LAIF 4815
P Ø6.0 W Neck	LAIF 6015 W

Transfer Impression Coping

- Components for fixture level impression taking
- Using closed tray
- Triangular arc structure for stable fastening and accurate repositioning
- Hand tightened with a 1.2 hex driver

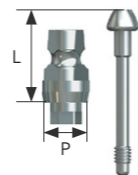

P/L	9.5 (Short)	12.5 (Long)
P Ø4.8 R	IIT 4807 S	IIT 4810 S
Pin	GTI 2014	GTI 2017
P Ø6.0 W Neck	IIT 6007 WS	IIT 6010 WS
Pin	GTI 2014 W	GTI 2017W

Pick-up Impression Coping

- Components for fixture level impression taking
- Using open tray
- Hand tightened with a 1.2 hex driver

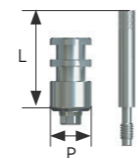

P/L	8 (Short)	14 (Long)
P Ø4.8 N	IPI 4808 MS	IPI 4812 MS
P Ø4.8 R	IPI 4808 S	IPI 4812 S
P Ø6.0 W Neck	IPI 6008 EWS	IPI 6012 EWS
Pin	GPI 2008	GPA 2013

Solid Analog

- An integrated Lab Analog of Solid Abutment & Fixture

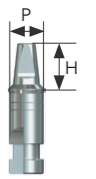

P/H	4.0	5.5	7.0
P Ø4.8 R	LAIS 48354 L	LAIS 48355 L	LAIS 48357 L
P Ø4.8 W Wide Solid	LAIS 4854 EL	LAIS 4855 EL	LAIS 4857 EL
P Ø6.0 W Wide Solid	LAIS 604 EWL	LAIS 605 EWL	LAIS 607 EWL

Plastic Impression Coping

- A Coping for the Impression of Solid Abutment



P Ø4.8 R	IPI 4810
P Ø4.8 W Wide Solid	IPI 4810 E
P Ø6.0 W Wide Solid	IPI 6010 EW

Burn-Out Cylinder

- Replacement of resin cap before wax up using rigid abutment
- Enabling the production of elaborate prosthesis with uniform interior
- Used after casting, after cleaning the margin for proper fitting



D/Type	Single	Bridge
P Ø4.8 R Solid	PCI 4801	PCI 4801 N
P Ø4.8 W Solid	PCI 4801 E	PCI 4801 E N

BR | EXTERNAL HEX IMPLANT SYSTEM

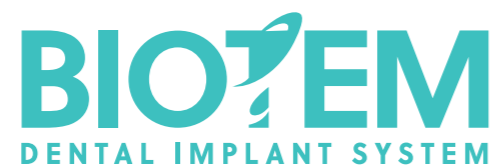

BR External Hex Implant System	60
BR Prosthetic Flow Chart	61
FXBR 3.3 Drilling Sequence	62
FXBR 3.7 Drilling Sequence	62
FXBR 4.0 Drilling Sequence	62
FXBR 4.5 Drilling Sequence	63
FXBR 5.0 Drilling Sequence	63
FXBR 6.0 Drilling Sequence	63
BR Fixture SLA	64
Cover Screw	65
Healing Abutment	65
Cemented Abutment (Hex)	66
Cemented Abutment (Non-Hex)	66
Angled Abutment	67
Plastic UCLA Abutment	68
Transfer Impression Coping	68
Pick-up Impression Coping	69
Lab Analog	69

BR | External Hex Implant System

Corkscrew Thread

- 0.7pitch x 0.375depth x double thread
- Synchronized thread
- Optimized design for RBM/SLA surface
- Powerful self threading
- High initial stability

Taper degree 1.5°

- Easy to get initial stability in soft bone

Apical

- High performance self-tapping
- High fixation

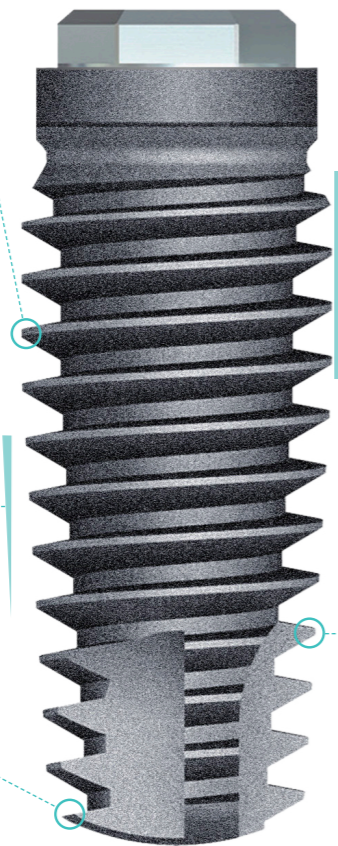

Straight Body

- Implantation performance
- Easy surgical protocol
- Decrease sensitivity on drill size

Cutting Edge

- Excellent Self Tapping ability

BR | Prosthetic Flow Chart

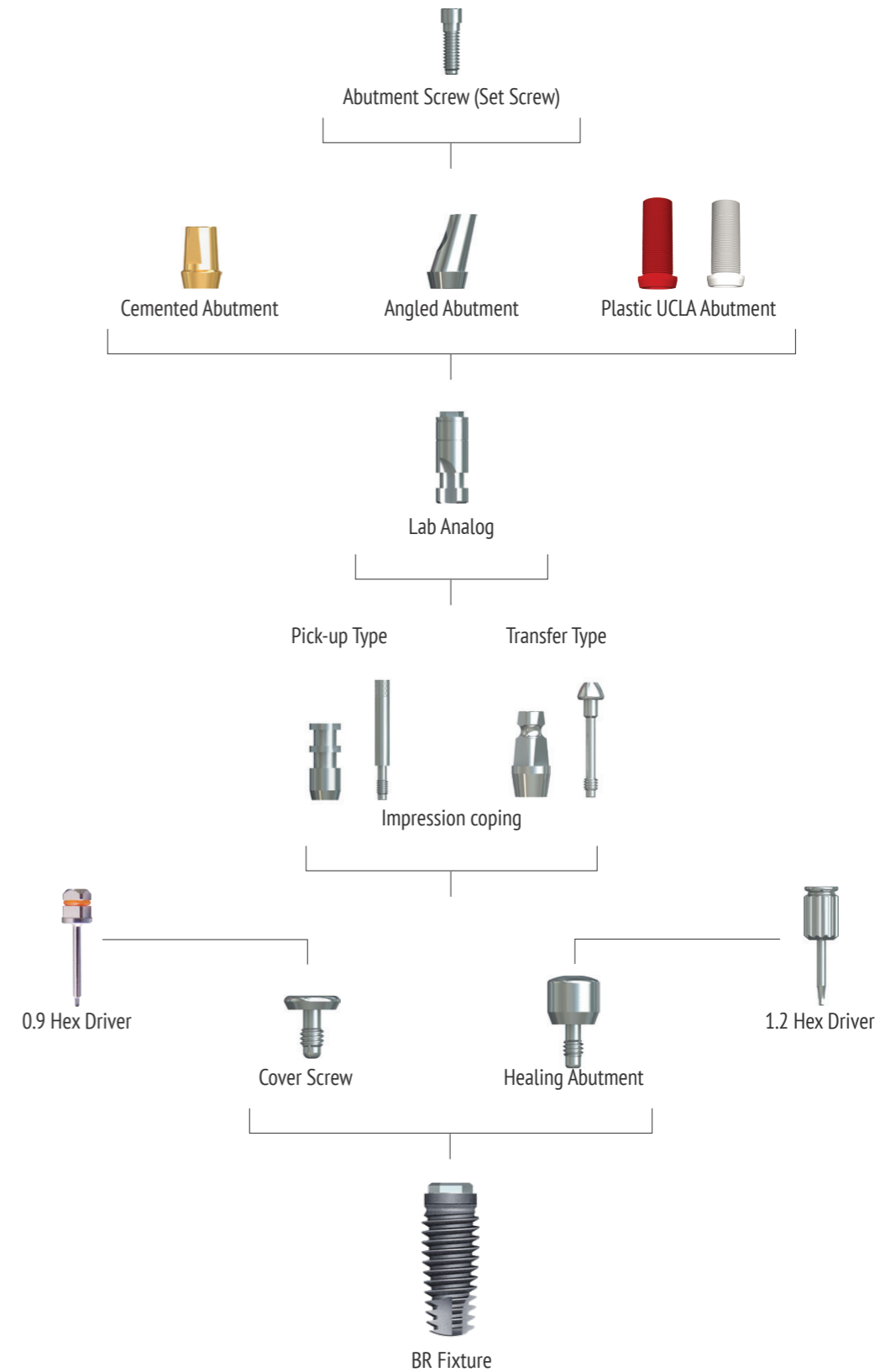

FXBR 3.3 | Drilling Sequence

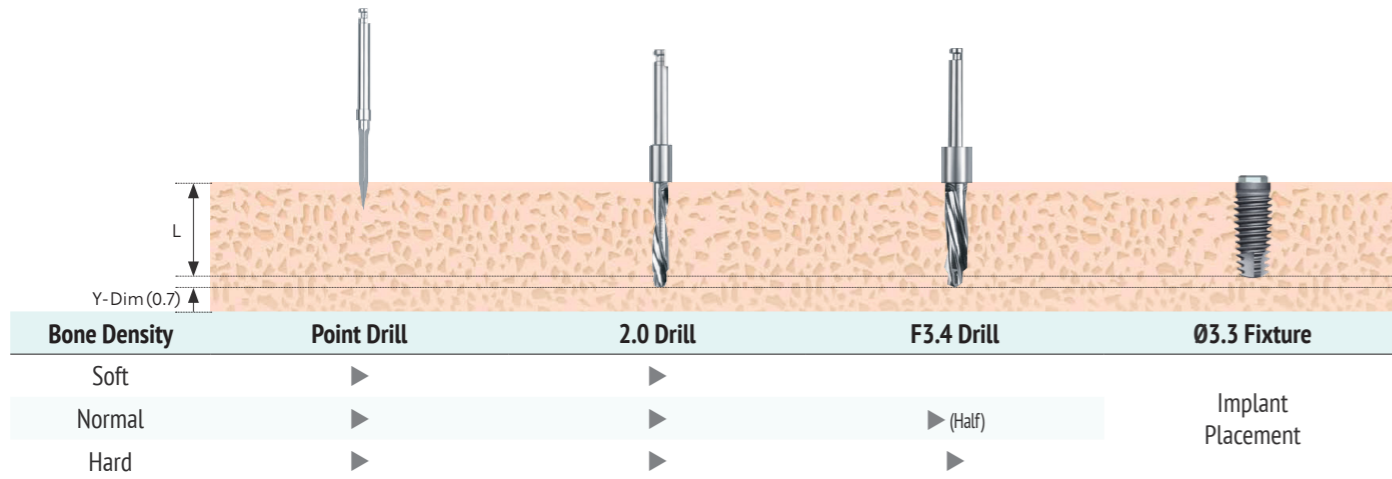

FXBR 3.7 | Drilling Sequence

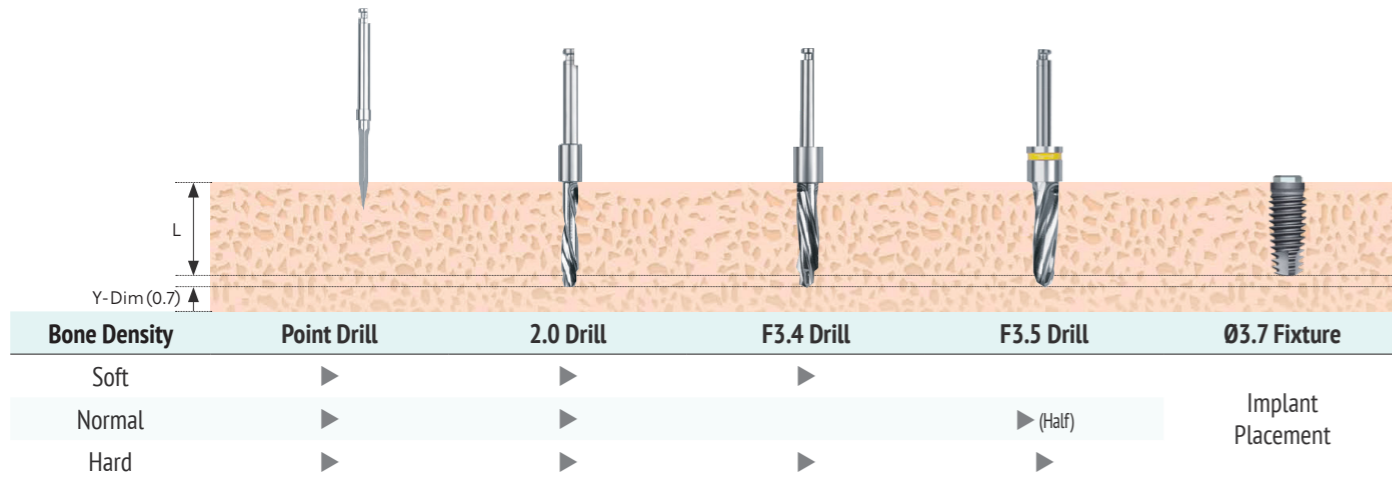

FXBR 4.0 | Drilling Sequence

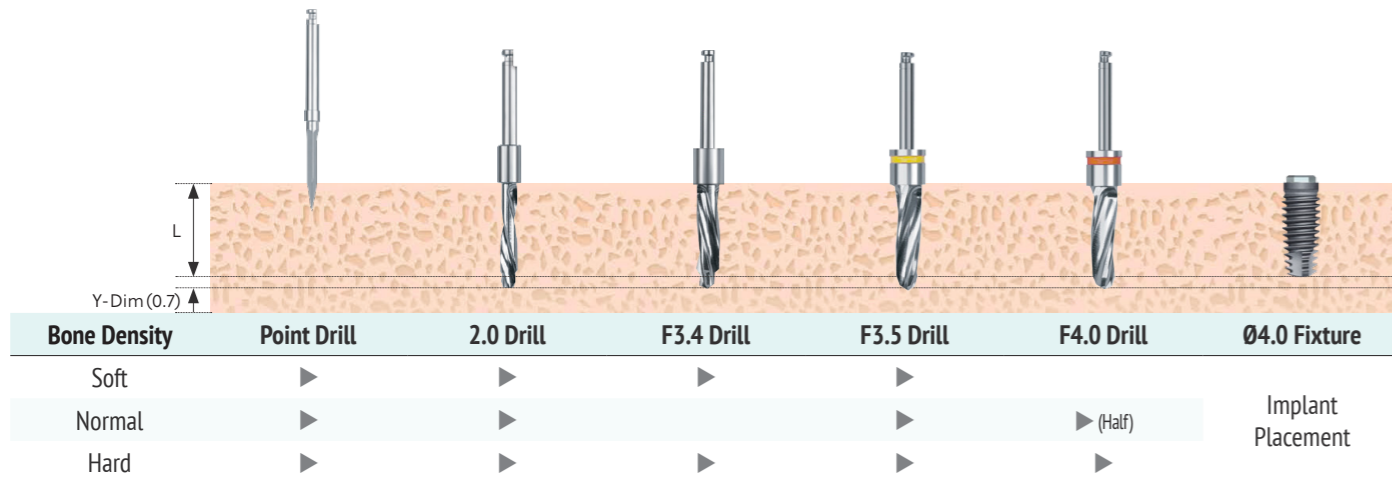

FXBR 4.5 | Drilling Sequence

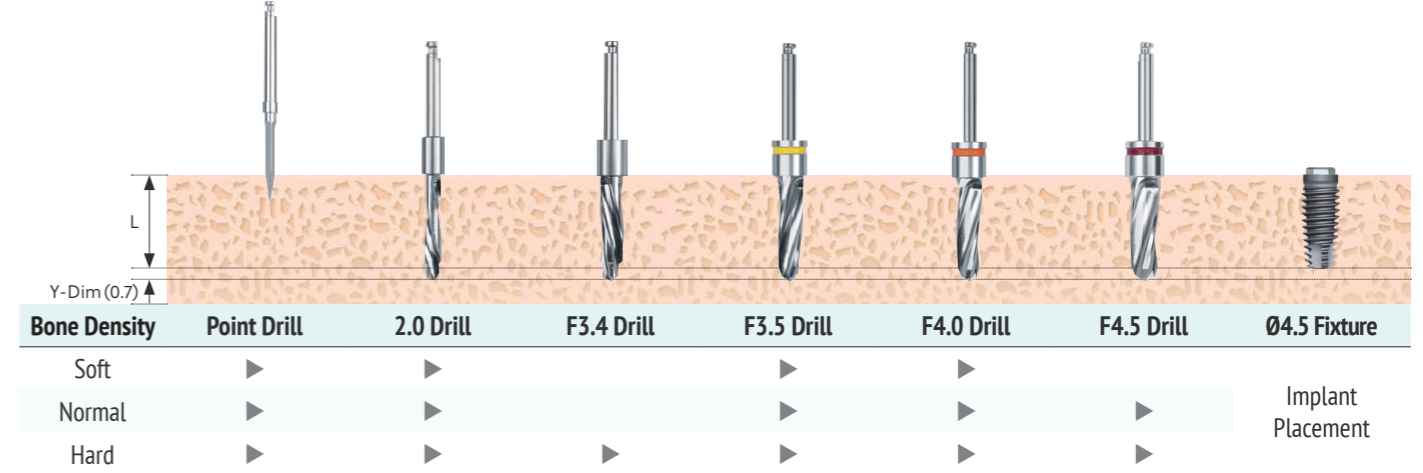

FXBR 5.0 | Drilling Sequence

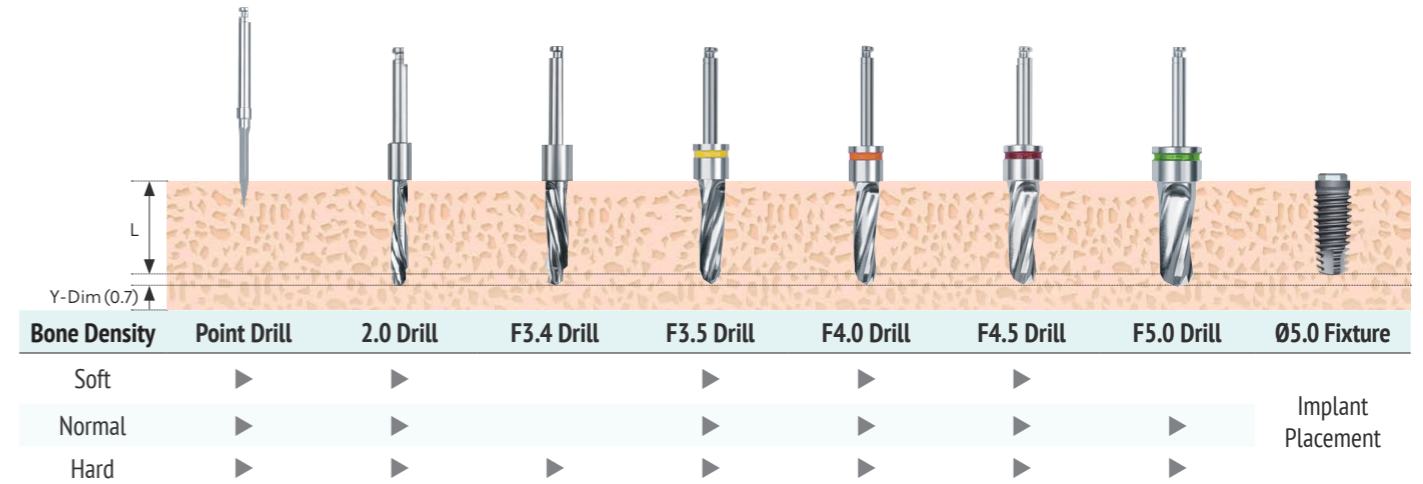

FXBR 6.0 | Drilling Sequence

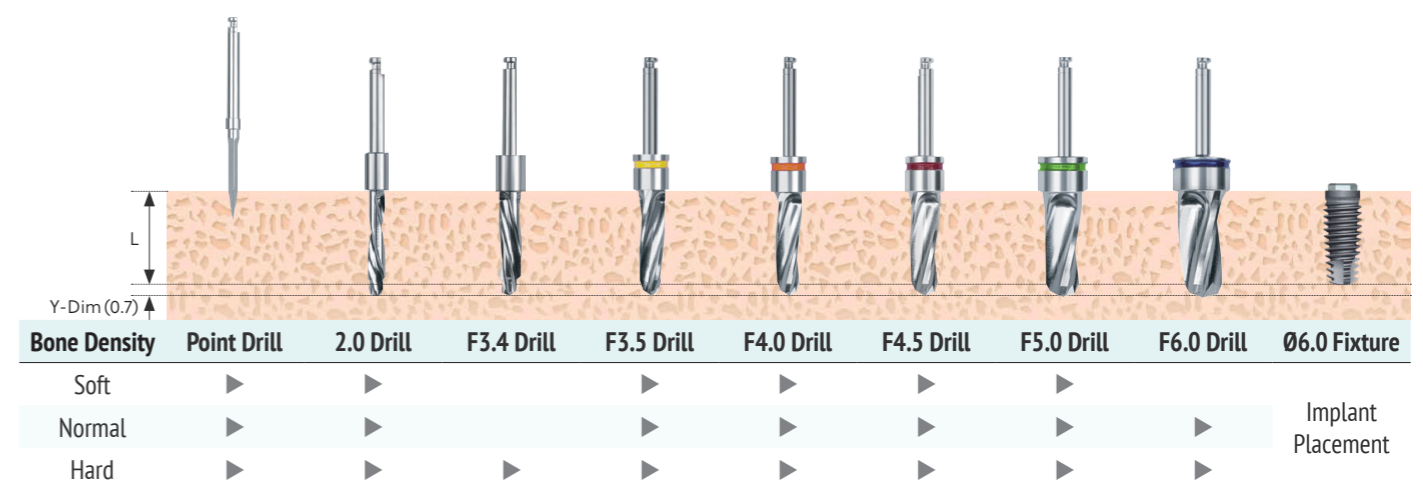

BR Fixture | SLA

- No Mount System : Using a special fixture driver with more durability and easy separation to fixture
- Surface : SLA

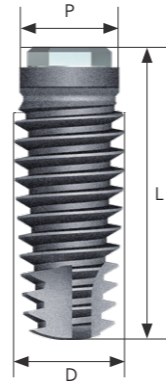

D/L	7.5	8.5	10	11.5	13	15	18
P Ø3.5 Hex 2.4 N	D Ø3.3	FXBR 3308 RS	FXBR 3310 RS	FXBR 3311 RS	FXBR 3313 RS	FXBR 3315 RS	
	D Ø3.75	FXBR 3707 RS	FXBR 3708 RS	FXBR 3710 RS	FXBR 3711 RS	FXBR 3713 RS	FXBR 3715 RS
P Ø4.1 Hex 2.7 R	D Ø4.0	FXBR 4007 RS	FXBR 4008 RS	FXBR 4010 RS	FXBR 4011 RS	FXBR 4013 RS	FXBR 4015 RS
	D Ø4.5	FXBR 4508 RS	FXBR 4510 RS	FXBR 4511 RS	FXBR 4513 RS		
P Ø5.1 Hex 3.4 W	D Ø5.0	FXBR 5007 RS	FXBR 5008 RS	FXBR 5010 RS	FXBR 5011 RS	FXBR 5013 RS	FXBR 5015 RS
	D Ø6.0	FXBR 6007 RSS	FXBR 6008 RSS	FXBR 6010 RSS	FXBR 6011 RSS	FXBR 6013 RSS	FXBR 6015 RSS
T-Type Hex 2.7 W-T	D Ø5.0	FXTR 5007 RS	FXTR 5008 RS	FXTR 5010 RS	FXTR 5011 RS	FXTR 5013 RS	FXTR 5015 RS

Cover Screw

- 0.9 Hex Driver
- Fastening torque : 5~8Ncm

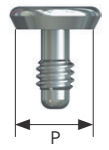

P Ø3.5 N	CSB 3501
P Ø4.1 R	CSB 4101
P Ø5.1 W	CSB 5001
P Ø5.0 W-T	CST 5000

Healing Abutment

- Use a 1.2 Hex Driver
- Fastening torque : 5~8Ncm

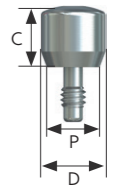

D/C	2	3	4	5	7
Ø4.0 N	HAB 35402		HAB 35404		
Ø5.0 R	HAB 41502	HAB 41503	HAB 41504	HAB 41505	HAB 41507
Ø6.0 R	HAB 41602	HAB 41603	HAB 41604	HAB 41605	HAB 41607
Ø6.0 W	HAB 50602	HAB 50603	HAB 50604	HAB 50605	
Ø6.0 W-T	HAT 50602	HAT 50603	HAT 50604	HAT 50605	HAT 50607

Cemented Abutment (Hex)

- An abutment for a single prosthesis.
- Using a 1.2 Hex Driver
- Fastening torque : Narrow 20Ncm
- Regular / Wide 30Ncm

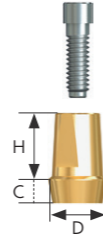

D/C		1	2	3	4
Ø4.0 N	H 6.0		SABT 35425 S		SABT 35445 S
	H 7.5	SABT 35417 S	SABT 35427 S		SABT 35447 S
	Screw	Abutment Screw M 1.6 (ABHS 1608)			
Ø5.0 R	H 4.0	SABT 40514 S	SABT 40524 S	SABT 40534 S	SABT 40544 S
	H 5.5	SABT 40515 S	SABT 40525 S	SABT 40535 S	SABT 40545 S
	H 7.0	SABT 40517 S	SABT 40527 S	SABT 40537 S	SABT 40547 S
Screw	Abutment Screw M 2.0 (ABHS 2008)				
Ø6.0 W	H 4.0	SABT 50614 S	SABT 50624 S	SABT 50634 S	SABT 50644 S
	H 5.5	SABT 50615 S	SABT 50625 S	SABT 50635 S	SABT 50645 S
	H 7.0	SABT 50617 S	SABT 50627 S	SABT 50637 S	SABT 50647 S
Screw	Abutment Screw M 2.5 (ABHS 2508)				
Ø6.0 T-Type W-T	H 4.0	SATT 50614 S	SATT 50624 S	SATT 50634 S	SATT 50644 S
	H 5.5	SATT 50615 S	SATT 50625 S	SATT 50635 S	SATT 50645 S
	H 7.0	SATT 50617 S	SATT 50627 S	SATT 50637 S	SATT 50647 S
Screw	Abutment Screw M 2.0 (ABHS 2008)				

Cemented Abutment (Non-Hex)

- An abutment for multiple prosthesis.
- Using a 1.2 Hex Driver
- Fastening torque : Narrow 20Ncm
- Regular / Wide 30Ncm

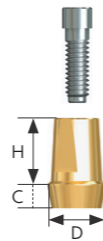

D/C		1	2	3	4
Ø4.0 N	H 7.5	SABT 35417 NS	SABT 35427 NS	SABT 35437 NS	SABT 35447 NS
	Screw	Abutment Screw M 1.6 (ABHS 1608)			
Ø5.0 R	H 7.0	SABT 40517 NS	SABT 40527 NS	SABT 40537 NS	SABT 40547 NS
	Screw	Abutment Screw M 2.0 (ABHS 2008)			
Ø6.0 W	H 5.5		SABT 50625 NS	SABT 50635 NS	
	H 7.0	SABT 50617 NS	SABT 50627 NS	SABT 50637 NS	SABT 50647 NS
	Screw	Abutment Screw M 2.5 (ABHS 2508)			
Ø6.0 T-Type W-T	H 5.5			SATT 50635 NS	
	Screw	Abutment Screw M 2.0 (ABHS 2008)			

Angled Abutment

- 15°/25° fixture insertion for angle compensation
- Using a 1.2 Hex Driver
- Fastening torque : Narrow 20Ncm
- Regular / Wide 30Ncm
- H : 7mm

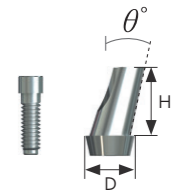

D/C		1	2	3	4
Ø4.0 N	$\theta^{\circ}15^{\circ}$	AABT 35115 S	AABT 35215 S	AABT 35315 S	AABT 35415 S
	$\theta^{\circ}25^{\circ}$	AABT 35125 S	AABT 35225 S	AABT 35325 S	AABT 35425 S
	Screw	Abutment Screw M 1.6 (ABHS 1608)			
Ø5.0 R	$\theta^{\circ}15^{\circ}$	AABT 40115 S	AABT 40215 S	AABT 40315 S	AABT 40415 S
	$\theta^{\circ}25^{\circ}$	AABT 40125 S	AABT 40225 S	AABT 40325 S	AABT 40425 S
	Screw	Abutment Screw M 2.0 (ABHS 2008)			
Ø6.0 W	$\theta^{\circ}15^{\circ}$		AABT 50215 S		AABT 50415 S
	$\theta^{\circ}25^{\circ}$		AABT 50225 S		AABT 50425 S
	Screw	Abutment Screw M 2.5 (ABHS 2508)			
Ø6.0 T-Type W-T	$\theta^{\circ}15^{\circ}$		AATT 50215 S		AATT 50415 S
	$\theta^{\circ}25^{\circ}$		AATT 50225 S		AATT 50425 S
	Screw	Abutment Screw M 2.0 (ABHS 2008)			

Plastic UCLA Abutment

- Abutment for producing cement-retained/combination/ screw-retained prosthesis
- Used to produce customized prosthesis by casting with nonprecious metal alloy up to the abutment joint
- Fixture level impression
- Tightened with a 1.2 hex driver
- Recommended tightening torque : 30Ncm

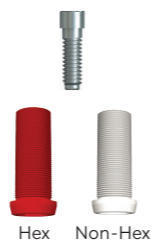

P Ø3.5 N	Hex	PABT 3540 S
	Non-Hex	PABT 3540 NS
	Screw	Abutment Screw M 1.6 (ABHS 1608)
P Ø4.0 R	Hex	PABT 4050 S
	Non-Hex	PABT 4050 NS
	Screw	Abutment Screw M 2.0 (ABHS 2008)
P Ø5.0 W	Hex	PABT 5060 S
	Non-Hex	PABT 5060 NS
	Screw	Abutment Screw M 2.5 (ABHS 2508)
P Ø5.0 T-Type W-T	Hex	PATT 5060 S
	Non-Hex	PATT 5060 NS
	Screw	Abutment Screw M 2.0 (ABHS 2008)

Transfer Impression Coping

- Components for fixture level impression taking
- Using closed tray
- Triangular arc structure for stable fastening and accurate repositioning
- Hand tightened with a 1.2 hex driver

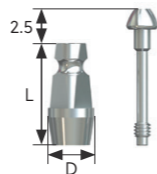

D/L	8 (Short)	11 (Long)
D Ø4.0 N	ITB 3508 TS	ITB 3511 TS
Pin	GTB 1611 T	GTB 1614 T
D Ø5.0 R	ITB 4108 TS	ITB 4111 TS
Pin	GTB 2011 T	GTB 2014 T
D Ø6.0 W	ITB 5108 TS	ITB 5111 TS
Pin	GTB 2511 T	GTB 2514 T

Pick-up Impression Coping

- Components for fixture level impression taking
- Using open tray
- Hand tightened with a 1.2 hex driver

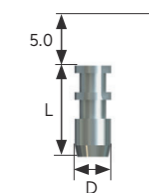

P/L	12
D Ø4.0 N	IPB 35412 S
Pin	GPB 1615
D Ø5.0 R	IPB 40512 S
Pin	GPB 2015
D Ø6.0 W	IPB 50612 S
Pin	GPB 2515

Lab Analog

- Lab analog for fixture level impression

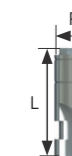

P/L	15 (Short)	18 (Long)
P Ø3.5 N	LAB 3515	
P Ø4.0 R	LAB 4015	LAB 4018
P Ø5.0 W	LAB 5015	LAB 5018
P Ø5.0 T-Type W-T	LAT 5015	

MR | ONE BODY IMPLANT SYSTEM

BIOEM
DENTAL IMPLANT SYSTEM

BOS 2.5/BOB 2.5 Drilling Sequence	72
BOS 3.0/BOB 3.0 Drilling Sequence	72
Micro Thread Type	73
Single Thread Type	74
Plastic Impression Coping	75
Plastic Temporary Cap	75
Lab Analog	75
Burn-out Cylinder	75
Denture Type	76
Retainer Cap Set	77
O-ring	77
O-ring Lab Analog	77
O-ring Abutment Torque driver	77

BOS 2.5/BOB 2.5 | Drilling Sequence

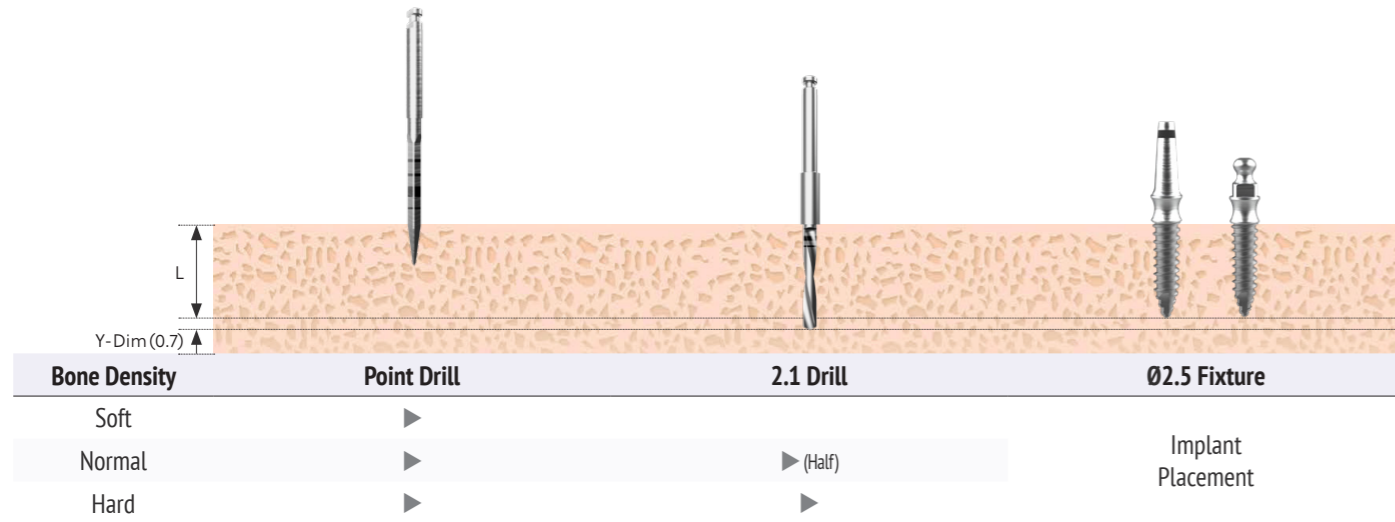

BOS 3.0/BOB 3.0 | Drilling Sequence

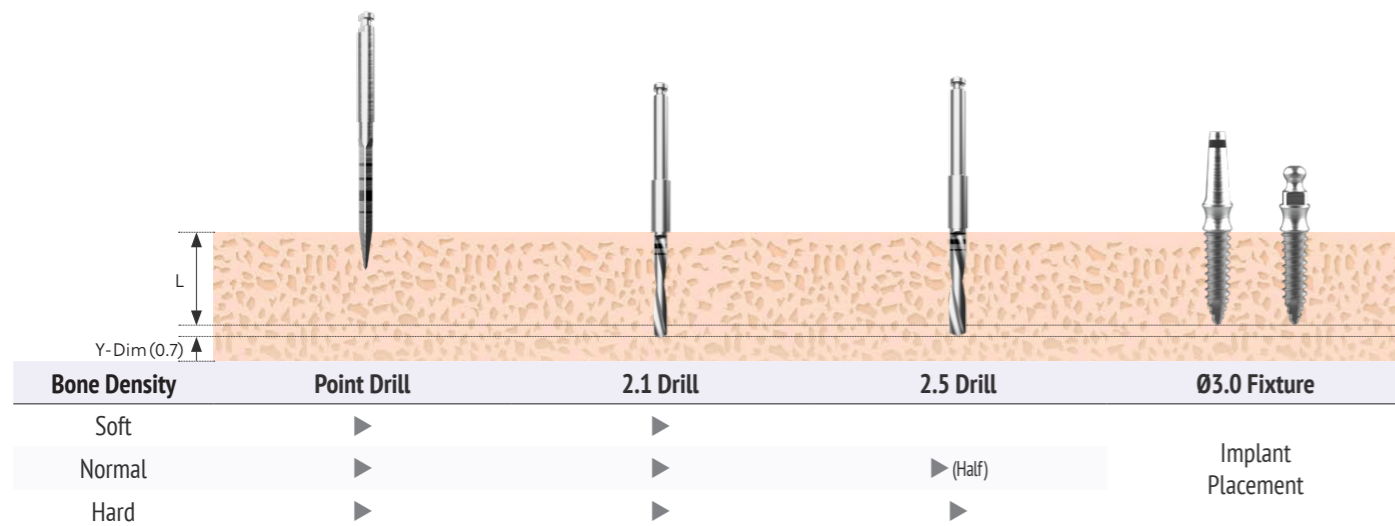

Micro Thread Type

- This implant is suitable for a narrow ridge, such as the lower anterior region
- Fixture and abutment are combined to withstand chewing pressure and Micro thread design was adopted to increase chewing power
- Surface treatment is sandblasted with alumina oxide and acid etched (SLA)
- The shape and the size of abutment part were optimized to enable prosthetics without cutting
- Temporary cap increases the convenience of manufacturing immediate prosthetics
- Impression cap and lab analog enable a sophisticated restorative process
- Optimal insertion torque : 30Ncm

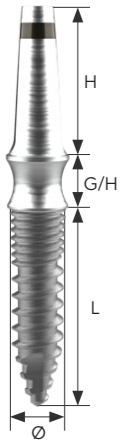

Code	Ø	L	G/H	H
BOM 2508S25	2.5	8.5	2.5	7.0
BOM 2510S25	2.5	10.0	2.5	7.0
BOM 2511S25	2.5	11.5	2.5	7.0
BOM 2513S25	2.5	13.0	2.5	7.0
BOM 2508S40	2.5	8.5	4.0	7.0
BOM 2510S40	2.5	10.0	4.0	7.0
BOM 2511S40	2.5	11.5	4.0	7.0
BOM 2513S40	2.5	13.0	4.0	7.0
BOM 3008S25	3.0	8.5	2.5	7.0
BOM 3010S25	3.0	10.0	2.5	7.0
BOM 3011S25	3.0	11.5	2.5	7.0
BOM 3013S25	3.0	13.0	2.5	7.0
BOM 3008S40	3.0	8.5	4.0	7.0
BOM 3010S40	3.0	10.0	4.0	7.0
BOM 3011S40	3.0	11.5	4.0	7.0
BOM 3013S40	3.0	13.0	4.0	7.0

Single Thread Type

- A single body, mini dental implant that is designed for narrow spaces such as the mandibular anterior jaw
- Surface treatment is sandblasted with alumina oxide and acid etched (SLA)
- Abutment shape and size is optimized for cutting-free prosthetic work
- Body and thread are designed for flawless insertion and excellent stability
- Optimal insertion torque : 30Ncm

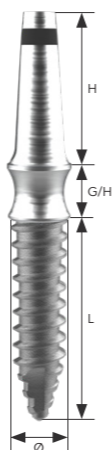

Code	Ø	L	G/H	H
BOS 2508S25	2.5	8.5	2.5	7.0
BOS 2510S25	2.5	10.0	2.5	7.0
BOS 2511S25	2.5	11.5	2.5	7.0
BOS 2513S25	2.5	13.0	2.5	7.0
BOS 2508S40	2.5	8.5	4.0	7.0
BOS 2510S40	2.5	10.0	4.0	7.0
BOS 2511S40	2.5	11.5	4.0	7.0
BOS 2513S40	2.5	13.0	4.0	7.0
BOS 3008S25	3.0	8.5	2.5	7.0
BOS 3010S25	3.0	10.0	2.5	7.0
BOS 3011S25	3.0	11.5	2.5	7.0
BOS 3013S25	3.0	13.0	2.5	7.0
BOS 3008S40	3.0	8.5	4.0	7.0
BOS 3010S40	3.0	10.0	4.0	7.0
BOS 3011S40	3.0	11.5	4.0	7.0
BOS 3013S40	3.0	13.0	4.0	7.0

Plastic Impression Coping

- Precise impressions



Code

BOPIC

Plastic Temporary Cap

- Fabricate provisional prosthesis



Code

BOPTC

Lab Analog

- Implementing the oral MR implant narrow ridge abutment on the working model



Code

MRPLA

Burn-out Cylinder

- Can be used as the framework for a prosthesis
- Used to clean the margin of a casted prosthesis



MRPBCS



MRPBCB

Code

MRPBCS

MRPBCB

Type

Single

Bridge

Denture Type

- A single body, mini dental implant that is designed for denture fixation
- Surface treatment is sandblasted with alumina oxide and acid etched (SLA)
- Comes in 2.5 or 4mm gingival heights
- Collar O-ball head for use with O-ring retention set
- Optimal insertion torque : 30Ncm

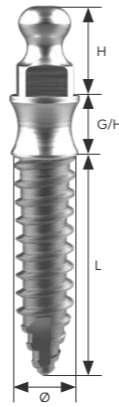

Code	Ø	L	G/H	H
BOB 2508S25	2.5	8.5	2.5	3.85
BOB 2510S25	2.5	10.0	2.5	3.85
BOB 2511S25	2.5	11.5	2.5	3.85
BOB 2513S25	2.5	13.0	2.5	3.85
BOB 2508S40	2.5	8.5	4.0	3.85
BOB 2510S40	2.5	10.0	4.0	3.85
BOB 2511S40	2.5	11.5	4.0	3.85
BOB 2513S40	2.5	13.0	4.0	3.85
BOB 3008S25	3.0	8.5	2.5	3.85
BOB 3010S25	3.0	10.0	2.5	3.85
BOB 3011S25	3.0	11.5	2.5	3.85
BOB 3013S25	3.0	13.0	2.5	3.85
BOB 3008S40	3.0	8.5	4.0	3.85
BOB 3010S40	3.0	10.0	4.0	3.85
BOB 3011S40	3.0	11.5	4.0	3.85
BOB 3013S40	3.0	13.0	4.0	3.85

Retainer Cap Set

- Packing unit : Retainer cap + O-ring



Code

BRCS

O-ring

- Packing unit : O-ring 1 piece



Code

BOR45R

O-ring Lab Analog

- Make Oral Ball abutments on the working model
- Packing unit : Lab analog



Code

MRBLA

O-ring Abutment Torque driver



Code

L

D

BOBTDS

Short

Ø 3.8

BOBTDL

Long

Ø 3.8

SURGICAL KIT

BIOEM
DENTAL IMPLANT SYSTEM

Surgical Kit	80
Point Drill	80
Straight Drill	80
Tapered Drill	81
Hex Driver For Hand (Manual)	82
Prosthetic type	82
Parallel Pin	82
Fixture Pin	82
Drill Extension	82
AR Fixture Driver (Machine)	83
AR Fixture Driver (Wrench)	83
IR Fixture Driver (Machine)	83
IR Fixture Driver (Wrench)	84
BR Fixture Driver (Machine)	84
BR Fixture Driver (Wrench)	84
IR Type Drill	85
Lindermann Drill	85
Cortical Drill	85
Convenient Kit	86
Convenient Kit Drilling Sequence	86
Point Drill	87
Straight Twist Drill	87
Drill Stopper	87
Stopper Drill	87
Hex Driver (Hex)	88
Parallel Pin	88
Fixture Pin	88
Drill Extension	88
Fixture Driver (Machine)	88
MR Kit	89
Drill for MR Implant	90
Driver for Narrow Ridge & Provisional Type	90
Driver for Denture Type	91
Gauge for MR Implant	91
Driver Separator	91
Surgical Guide Kit	92
Guide Point Drill	92
Tissue Punch Drill	92
Guide Anchor Screw	92
Guide Cortical Drill	92
Guide Vertical Anchor	93
Guide Anchor Drill	93
Guide Anchor Driver	93
Guide Drill Tube	93
Guide Bone Profiler Drill	93
Guide Fixture Driver (Machine)	94
Guide Fixture Driver (Wrench)	94
Screw Driver : Hex 1.2 (short)	94
Torque Wrench	94
Drill Extension	94
Guide Straight Twist Drill	95
How to pick up the fixture	96

SURGICAL KIT

Surgical Kit

• Biotem surgical kit set with excellent drilling function and convenient surgical procedure.

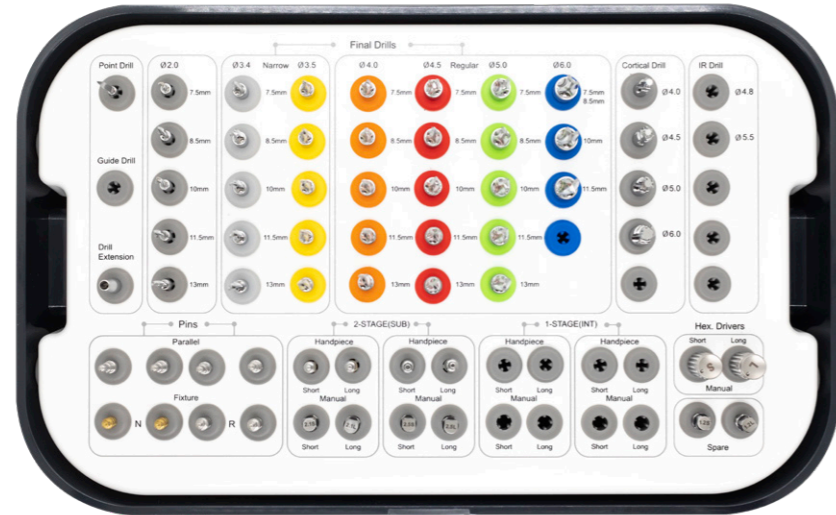

Lower panel component

Torque Wrench TRA45_m

Product Code	BHS
--------------	-----

SURGICAL KIT COMPONENT

Point Drill

Product Code	MGD 2000
--------------	----------



Straight Drill

L	7.5	8.5	10	11.5	13
Product Code	BPD 2207	BPD 2208	BPD 2210	BPD 2211	BPD 2213



SURGICAL KIT COMPONENT

Tapered Drill

F 3.4

L	7.5	8.5	10	11.5	13
Product Code	BPD 3007	BPD 3008	BPD 3010	BPD 3011	BPD 3013

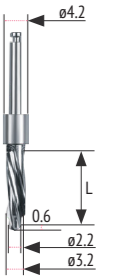

F 3.5

L	7.5	8.5	10	11.5	13
Product Code	BPD 3507	BPD 3508	BPD 3510	BPD 3511	BPD 3513

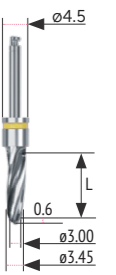

F 4.0

L	7.5	8.5	10	11.5	13
Product Code	BPD 4007	BPD 4008	BPD 4010	BPD 4011	BPD 4013

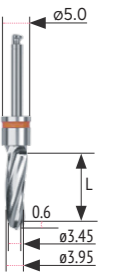

F 4.5

L	7.5	8.5	10	11.5	13
Product Code	BPD 4507	BPD 4508	BPD 4510	BPD 4511	BPD 4513

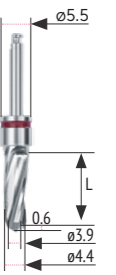

F 5.0

L	7.5	8.5	10	11.5	13
Product Code	BPD 5007	BPD 5008	BPD 5010	BPD 5011	BPD 5013

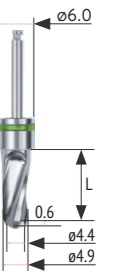

F 6.0

L	8.5	10	11.5
Product Code	BPD 6008	BPD 6010	BPD 6011

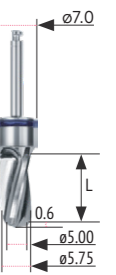

Hex Driver For Hand (Manual)

Diameter	Product Code	Type
0.9mm (BR)	HDT 0909	Short
	HDT 0915	Long
1.2mm	HDT 1209	Short
	HDT 1215	Long



Prosthetic type

Diameter	Product Code	Type
0.9 mm (BR)	HDB 0915	Long
1.2 mm	MHD 1200S	Short
	MHD 1200L	Long



Parallel Pin

Product Code
BPP2230



Fixture Pin

Diameter	Product Code
N Ø 2.1	BFFP 3500
R Ø 2.5	BFFP 4500



Drill Extension

Product Code
DE_Ⓜ



AR Fixture Driver (Machine)

Diameter	Product Code	Type
N	BFMD 3521 S	Short
	BFMD 3521 L	Long
R W	BFMD 4525 S	Short
	BFMD 4525 L	Long



AR Fixture Driver (Wrench)

Diameter	Product Code	Type
N	BFHD 3521 S	Short
	BFHD 3521 L	Long
R W	BFHD 4525 S	Short
	BFHD 4525 L	Long



IR Fixture Driver (Machine)

Diameter	Product Code	Type
N	BFMD 4531 S	Short
	BFMD 4531 L	Long
R W	BFMD 4529 S	Short
	BFMD 4529 L	Long



IR Fixture Driver (Wrench)

Diameter	Product Code	Type
N	BFHD 4531 S	Short
	BFHD 4531 L	Long
R W	BFHD 4529 S	Short
	BFHD 4529 L	Long



BR Fixture Driver (Machine)

Diameter	Product Code	Type
N	FDBM 3512 C	Long
R	FDBM 4108 C	Short
	FDBM 4112 C	Long
W	FDBM 5008	Short



BR Fixture Driver (Wrench)

Diameter	Product Code	Type
N	FDBH 3515	Long
R	FDBH 4115	Long
W	FDBH 5012	Long



IR Type Drill

L/D	Ø 4.8	Ø 5.5
Product Code	BPD 4813	BPD 5513



Lindermann Drill

Product Code
LMD 20



Cortical Drill

D	Ø 4.0	Ø 4.5	Ø 5.0	Ø 6.0
Product Code	CDA 4011 T	CDA 4511 T	CDA 5011 T	CDA 6011 T

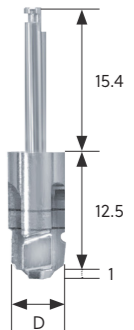

Convenient Kit

• Biotem surgical kit set with excellent drilling function and convenient surgical procedure.

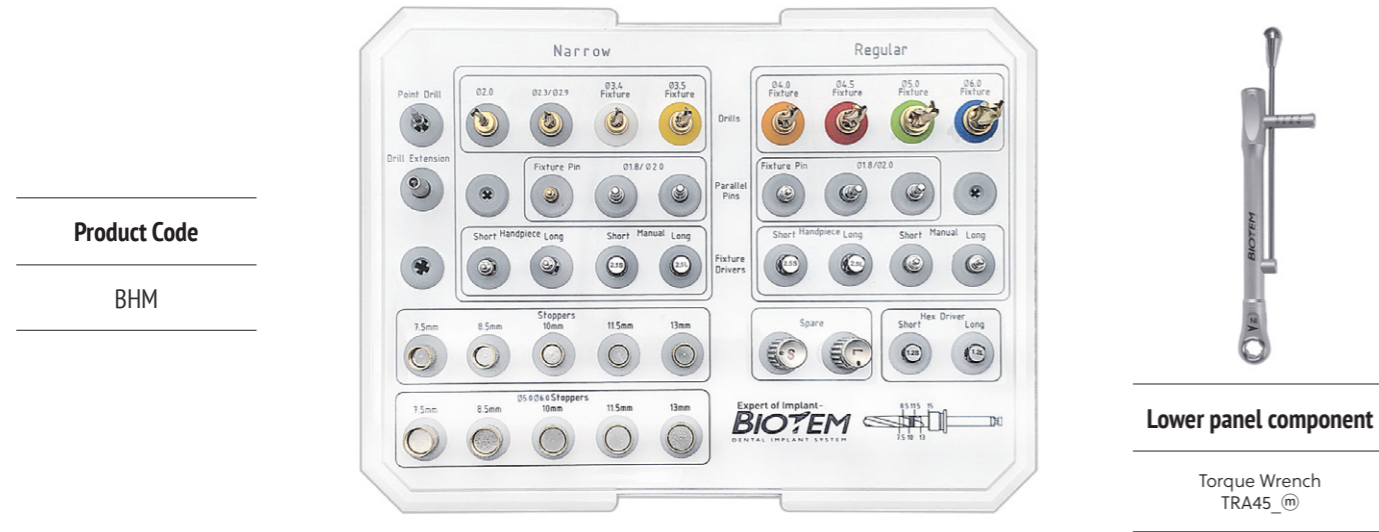

Convenient Kit Drilling Sequence

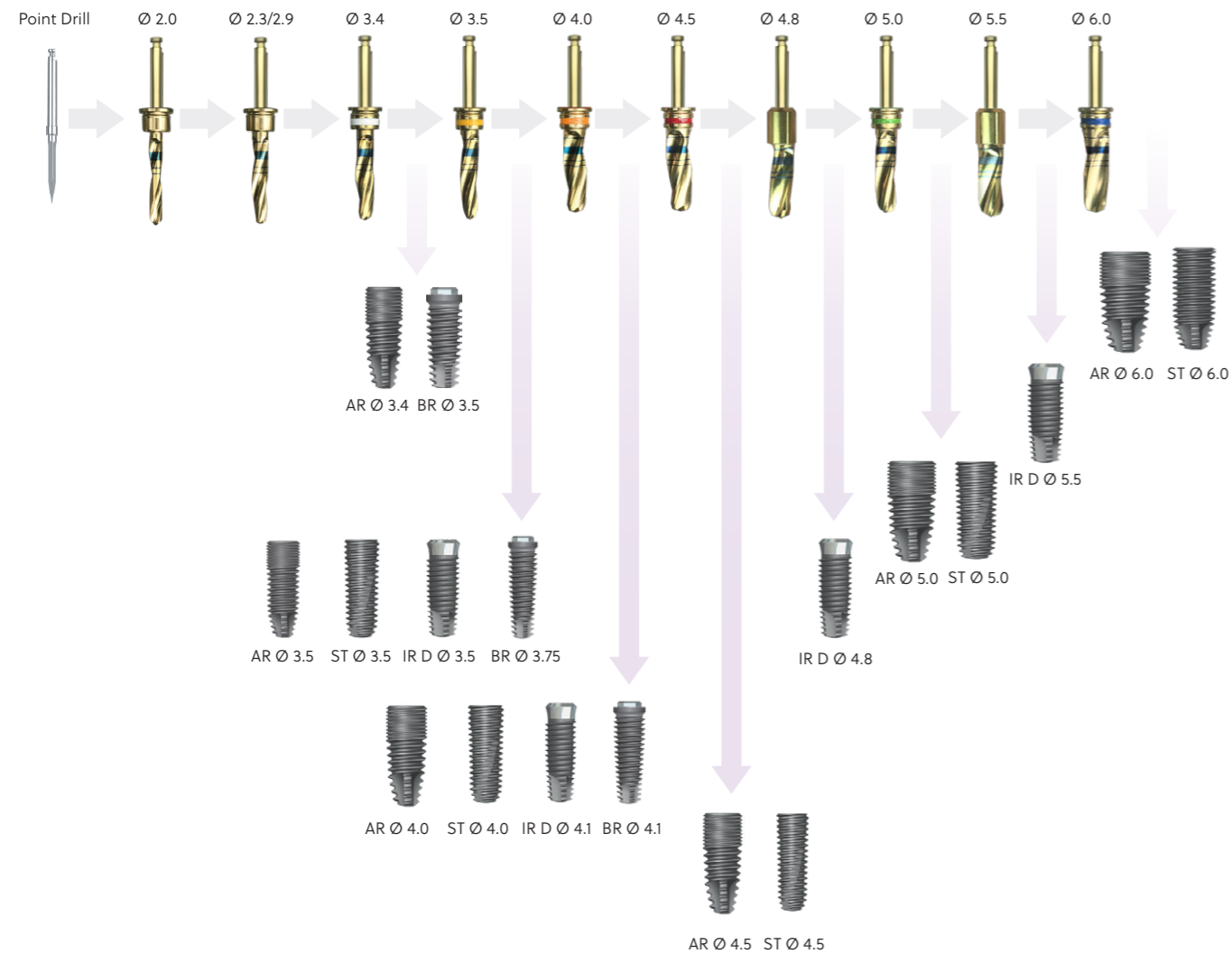

Point Drill

Product Code	MGD 2000
--------------	----------

Straight Twist Drill

D/L	15
Ø 2.0	BPSD 2215
Ø 2.3 / 2.9	BPSD 2815

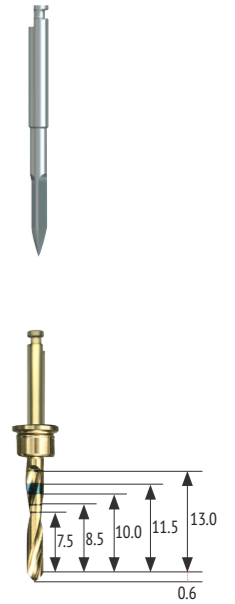

Drill Stopper

D	7.5	8.5	10	11.5	13
N R	BDS 5207	BDS 5208	BDS 5210	BDS 5211	BDS 5213
W	BDS 6507	BDS 6508	BDS 6510	BDS 6511	BDS 6513



Stopper Drill

D	Ø 3.4	Ø 3.5	Ø 4.0	Ø 4.5	Ø 5.0	Ø 6.0
Product Code	BPSD 3215	BPSD 3515	BPSD 4015	BPSD 4515	BPSD 5015	BPSD 6015

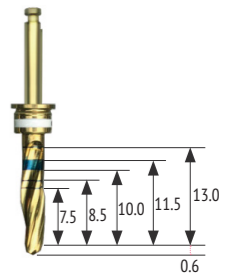
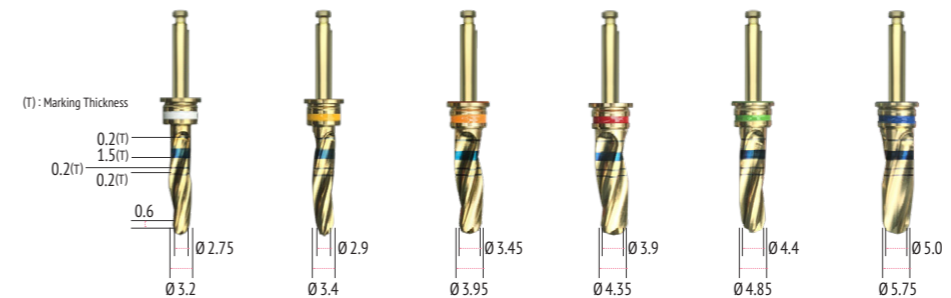

Hex Driver (Hex)

Diameter	Product Code	Length
1.2mm	HDT 1209	Short
	HDT 1215	Long



Parallel Pin

Product Code
BPP2230



Fixture Pin

D	Ø 2.1	Ø 2.5
Product Code	BFFP 3500	BFFP 4500



Drill Extension

Product Code
DE_m



Fixture Driver (Machine)

Diameter	Product Code	Length
N	BFMD 3521 S	Short
	BFMD 3521 L	Long
R W	BFMD 4525 S	Short
	BFMD 4525 L	Long



Fixture Driver (Wrench)

Diameter	Product Code	Length
N	BFHD 3521 S	Short
	BFHD 3521 L	Long
R W	BFHD 4525 S	Short
	BFHD 4525 L	Long



MR Kit

Product Code
BOK

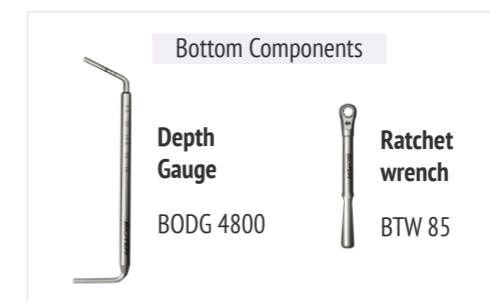
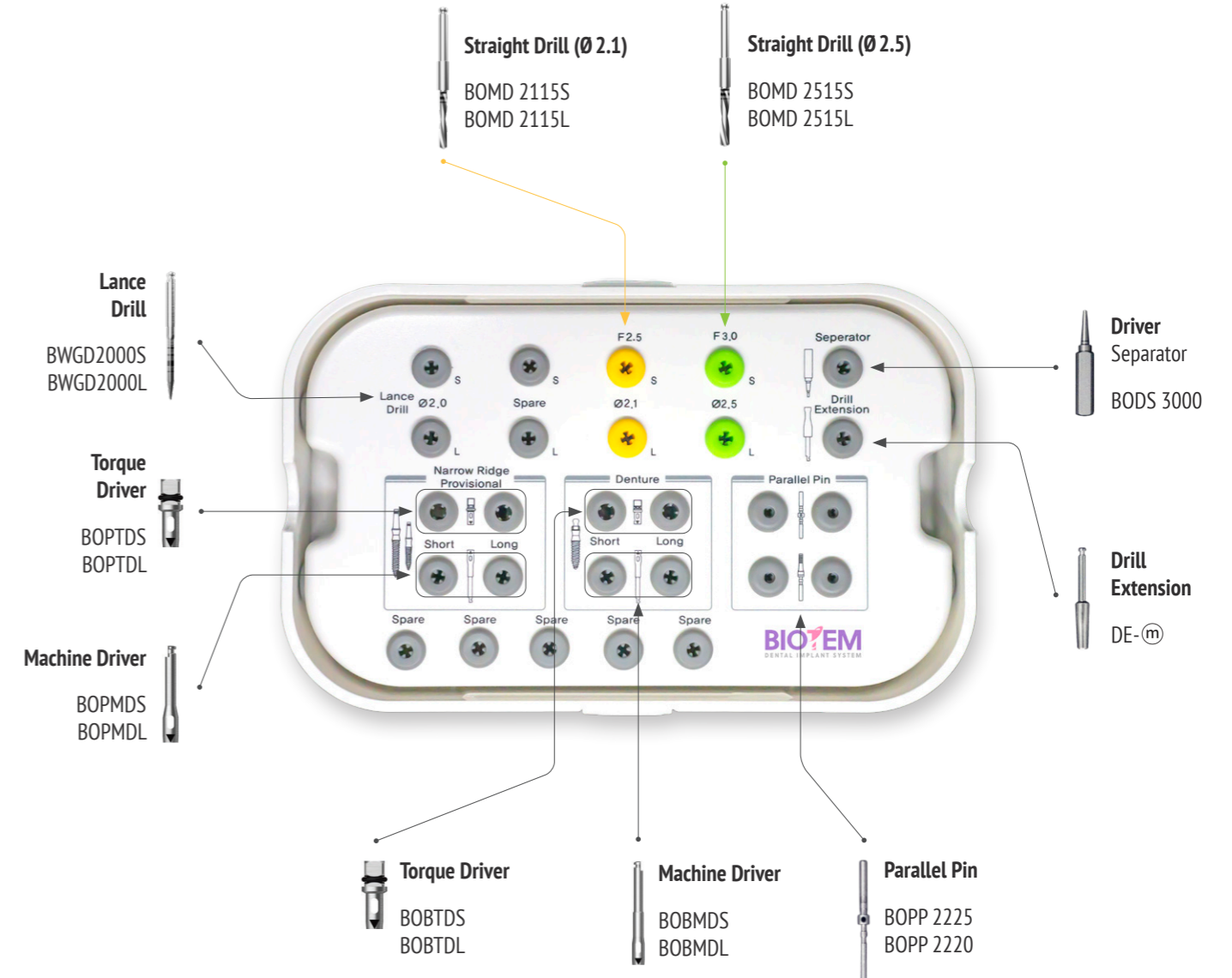

Drill for MR Implant

- High visibility during surgery with laser markings at 8, 10, 11.5, 13, and 15, measurements correspond to the length of MR implants.
- The Lance Drill is for cortical bone only; however, it is possible to drill up to marker depending upon the surgical situation.

Lance drill

Code	L	D
BWGD2000S	Short	Ø 2.0
BWGD2000L	Long	Ø 2.0

Straight Drill

Code	L	D
BOMD2115S	Short	Ø 2.1
BOMD2115L	Long	Ø 2.1
BOMD2515S	Short	Ø 2.5
BOMD2515L	Long	Ø 2.5



Driver for Narrow Ridge & Provisional Type

- Driver for the MR implant narrow ridge and provisional type
- Connect by matching up the triangle marker with the cross section of the implant (as shown)

Torque driver

Code	L	D
BOPTDS	Short	Ø 3.8
BOPTDL	Long	Ø 3.8



Machine driver

Code	L	D
BOPMDS	Short	Ø 3.8
BOPMDL	Long	Ø 3.8



Driver for Denture Type

- Driver for MR implant denture
- Connect by matching up the triangle marker with the cross section of the implant (as shown)

O-ring Abutment Torque driver

Code	L	D
BOBTDS	Short	Ø 3.8
BOBTDL	Long	Ø 3.8



O-ring Abutment Machine driver

Code	L	D
BOBMDS	Short	Ø 3.8
BOBMDL	Long	Ø 3.8



Gauge for MR Implant

- Depth gauge
 - Left side: Measures drilling depth
 - Right side: Used to modify the MR Implant Provisional neck angle
- Never modify the MR narrow ridge neck
- Parallel pin is used to check the path after drilling

	Code
Depth gauge	BODG4800
Ratchet wrench	BTW85



Ratchet wrench

Driver Separator

- Use when the driver is wedged with the implant. Insert the driver separator into the opening on the driver, and lever the driver off the implant.

Code
BODS3000



Surgical Guide Kit

Product Code

GSK

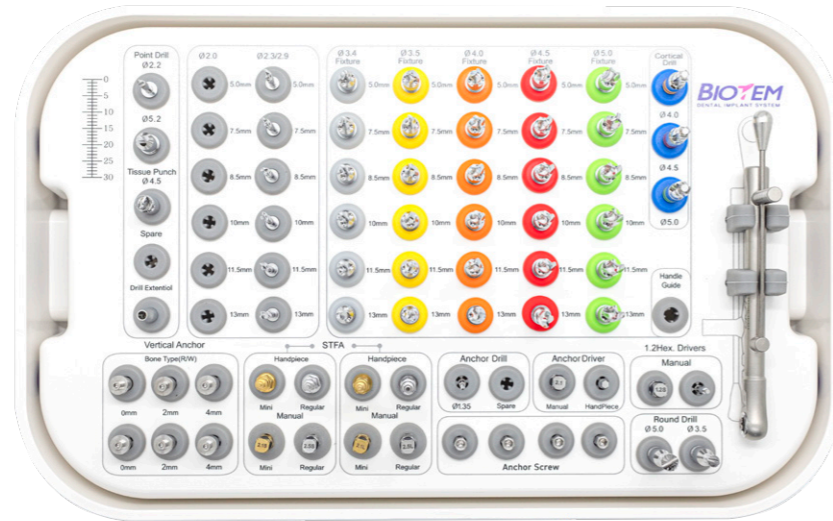

Guide Point Drill

Product Code	BGD 2205	BGDB 5205
Marking	Ø 2.2	Ø 5.2



Tissue Punch Drill

Product Code	BTPD 4500
Marking	Ø 4.5



Guide Anchor Screw

Product Code	BGAS 1809
--------------	-----------



Guide Cortical Drill

Product Code	BGCD 4000	BGCD 4500	BGCD 5000
Marking	Ø 4.0 (orange)	Ø 4.5 (red)	Ø 5.0 (green)

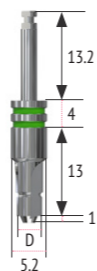

Guide Vertical Anchor

Product Code	BGVA 4500	BGVA 4501	BGVA 4503
Marking	0 mm	2 mm	4 mm



Guide Anchor Drill

Product Code	BGAD 1309
Marking	Ø 1.35



Guide Anchor Driver

Type	Machine	Wrench
Product Code	BGAMD21	BGATD21



Guide Drill Tube

Product Code	BGDT 2200
Marking	Ø 2.2



Guide Bone Profiler Drill

Product Code	BGBF 5035	BGBF 5050
Marking	Ø 3.5	Ø 5.0



Guide Fixture Driver (Machine)

Diameter	Product Code	Type
N	BGFMD 21S	Short
	BGFMD 21L	Long
R W	BGFMD 25S	Short
	BGFMD 25L	Long

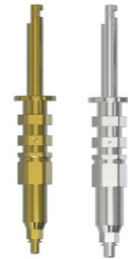

Guide Fixture Driver (Wrench)

Diameter	Product Code	Type
N	BGFTD 21S	Short
	BGFTD 21L	Long
R W	BGFTD 25S	Short
	BGFTD 25L	Long



Screw Driver : Hex 1.2 (short)

Type	Machine	Wrench
Product Code	HDM 12S	MHD 1200S



Torque Wrench

Product Code	TRA 45_Ⓜ
--------------	----------



Drill Extension

Product Code	DE_Ⓜ
--------------	------



Guide Straight Twist Drill

Ø 2.2

L	5	7.5	8.5	10	11.5	13
Product Code	BGSTD 2205	BGSTD 2207	BGSTD 2208	BGSTD 2210	BGSTD 2211	BGSTD 2213



Ø 3.4

L	5	7.5	8.5	10	11.5	13
Product Code	BGSTD 3005	BGSTD 3007	BGSTD 3008	BGSTD 3010	BGSTD 3011	BGSTD 3013



Ø 3.5

L	5	7.5	8.5	10	11.5	13
Product Code	BGSTD 3505	BGSTD 3507	BGSTD 3508	BGSTD 3510	BGSTD 3511	BGSTD 3513



Ø 4.0

L	5	7.5	8.5	10	11.5	13
Product Code	BGSTD 4005	BGSTD 4007	BGSTD 4008	BGSTD 4010	BGSTD 4011	BGSTD 4013



Ø 4.5

L	5	7.5	8.5	10	11.5	13
Product Code	BGSTD 4505	BGSTD 4507	BGSTD 4508	BGSTD 4510	BGSTD 4511	BGSTD 4513



Ø 5.0

L	5	7.5	8.5	10	11.5	13
Product Code	BGSTD 5005	BGSTD 5007	BGSTD 5008	BGSTD 5010	BGSTD 5011	BGSTD 5013



How to pick up the fixture



1
Take off the ampoule cap from ampoule with hand



2
Pick up the fixture



3
Detach fixture from the ampoule

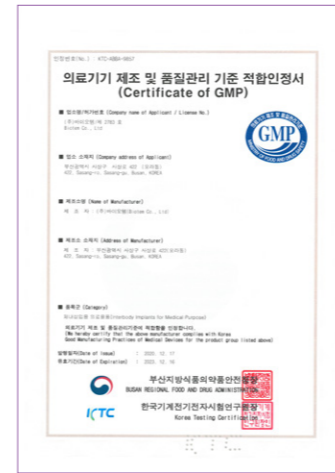

KGMP Certificate



CE Certificate



ISO 13485 Certificate

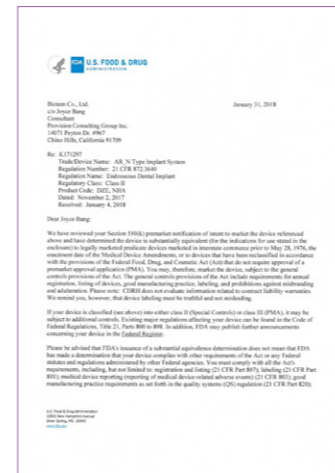

FDA 510(K) AR

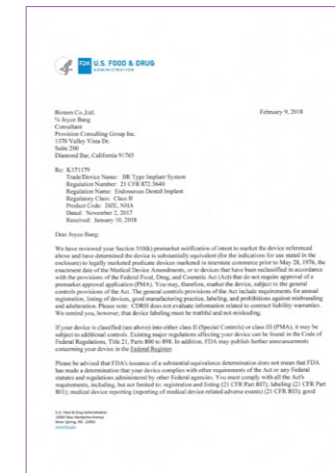

FDA 510(K) BR



FDA 510(K) IR



RUSSIA Certificate



JAPAN Certificate

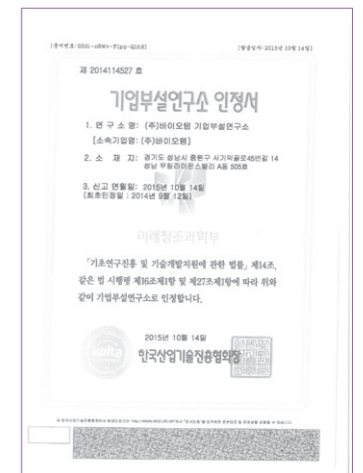

R&D Institute Certificate

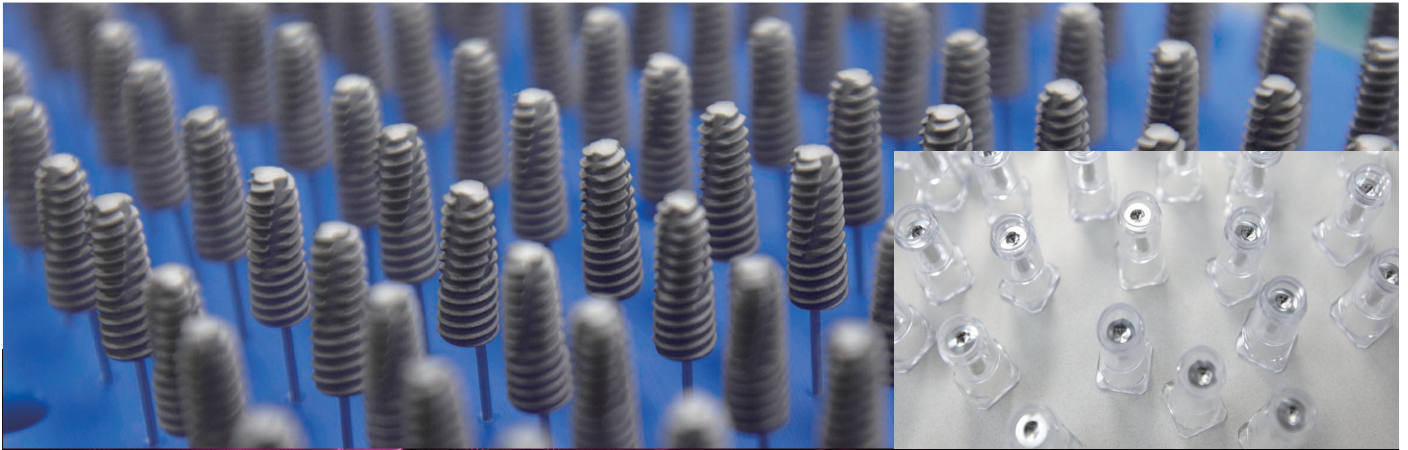

World-wide accredited implant Biotem Implant!



Biotem-expert of dental implant has been leading the world class dental implant technology and enhancing the satisfactory for the stability of quality and surgical convenience for the patients and dentists.

We have gained the international certificates such as CE0120, ISO13485 with together K.G.M.P and have stepped into the world wide market. We will make every effort to become an excellent world-leading implant company by developing high standardized, better quality and more satisfied products.



ISO 13485



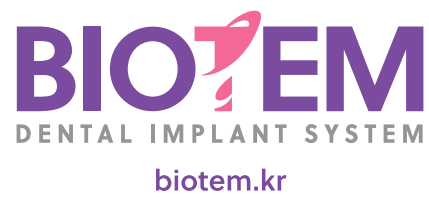

 #435-#438, Da-dong, Misagangbyeon Skypolis, 135, Misagangbyeonhangang-ro, Hanam-si, Gyeonggi-do, Korea
Tel. +82-2-6278-3050 ~ 1 Fax. +82-2-6278-3052

 422, Sasang-ro, Sasang-gu, Busan, Korea
Tel. +82-70-8220-4934 Fax. +82-51-908-8257